BuzziBlinds

Product Specification Sheet

This document contains technical information about the BuzziBlinds



www.buzzi.space



Acoustical performance and privacy with a twist

After the introduction in 2011 BuzziBlinds Classic became an instant hit as partitions for open-plan spaces. Five year later it's time to add some zest to the family. BuzziBlinds are inspired on modernist architecture. The rhythm and tonalities created by the orientation of the V-cut BuzziBlinds add a dynamic of depth to any space.

The free-standing room divider is made up of a series of five rotating acoustic blinds. With a simple twist, the blinds can be opened or closed to varying degrees to create privacy or open-up a space. This gives individuals the opportunity to determine the level of privacy they may want or need at any given moment to concentrate on a specific task.

BuzziBlinds consists of 4 different shapes. The Blinds are covered with plane BuzziFelt. Adding a V-cut feature to the BuzziFelt enhances a stronger architectural look in your space.

Design by Alain Gilles

General

 Straight | Wedge | Beach | Arch
M | L

 Baseplate: powder coated metal
Blinds: core aluminium
BuzziFelt cover

 M: H 155 cm W 149 cm D 49 cm
 H 61.02" W 58.66" D 19.29"
L: H 190 cm W 149 cm D 49 cm
 H 74.80" W 58.66" D 19.29"

 M: 45 kg
 99.21 lbs
L: 49 kg
 108.03 Lbs

 Dry use

 Flat packed

Baseplate colour in black (RAL 9005) or white (RAL 9010)

Blinds felt with or without V-cut

Optional extra layer Fabric, Rough, Trevira CS+ | CS, Revive 1, Revive 2, Terra, Clara 2, Remix 2, Hero,

... Tonus 4, Tonus Meadow, Memory 2 or Matrix
(extra layer not possible for V-cut)
Multicolour (front & back different colour)
Wheels (4pcs)

Acoustics



Attenuation



Diffusion

Content

Configurations	3	Dimensions	11
Overview	5	Acoustics	13
Fabrics	7		

Configurations

BuzziBlinds Straight

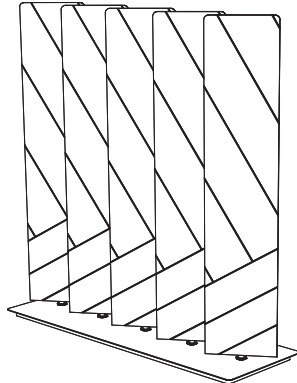

Straight
Front - Back



Straight V-cut
lines 1 Front



Straight V-cut
lines 1 Back

M | L

Baseplate: powder coated metal

Blinds: core aluminium
BuzziFelt cover

M: H 155 cm, W 149 cm, D 49 cm

H 61.02", W 58.66", D 19.29"



L: H 190 cm, W 149 cm, D 49 cm

H 74.80", W 58.66", D 19.29"

Baseplate colour in black (RAL 9005) or
white (RAL 9010)

Blinds felt with or without V-cut

Optional extra layer Fabric, Rough,
Trevira CS+ |CS, Revive 1, Revive 2, Terra,
Clara 2, Remix 2, Hero, Tonus 4,

Tonus Meadow, Memory 2 or Matrix

(extra layer not possible for V-cut)

Multicolour (front & back different colour)

Wheels (4pcs)

BuzziBlinds Wedge

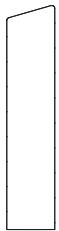
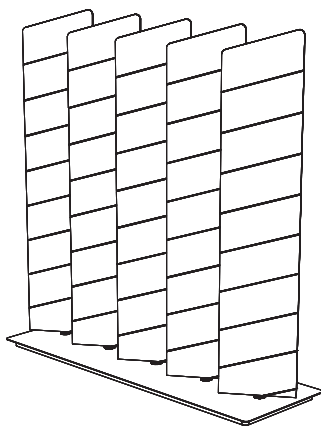

Wedge
Front - Back



Wedge V-cut
lines 1 Front



Wedge V-cut
lines 1 Back

M | L

Baseplate: powder coated metal

Blinds: core aluminium
BuzziFelt cover

M: H 155 cm, W 149 cm, D 49 cm

H 61.02", W 58.66", D 19.29"



L: H 190 cm, W 149 cm, D 49 cm

H 74.80", W 58.66", D 19.29"

Baseplate colour in black (RAL 9005) or
white (RAL 9010)

Blinds felt with or without V-cut

Optional extra layer Fabric, Rough,
Trevira CS+ |CS, Revive 1, Revive 2, Terra,
Clara 2, Remix 2, Hero, Tonus 4,
Tonus Meadow, Memory 2 or Matrix

(extra layer not possible for V-cut)

Multicolour (front & back different colour)

Wheels (4pcs)

BuzziBlinds Beach

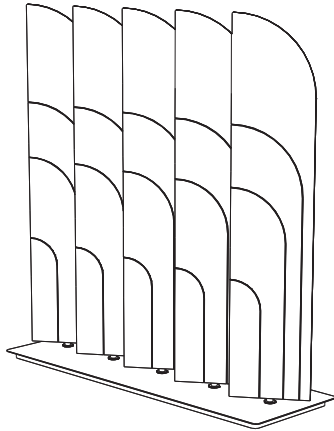

Beach
Front - Back



Beach V-cut
lines 1 Front



Beach V-cut
lines 1 Back

🏷️ M | L

Baseplate: powder coated metal

🌲 Blinds: core aluminium
BuzziFelt cover

M: H 155 cm, W 149 cm, D 49 cm
H 61.02", W 58.66", D 19.29"

✂️

L: H 190 cm, W 149 cm, D 49 cm
H 74.80", W 58.66", D 19.29"

Baseplate colour in black (RAL 9005) or white (RAL 9010)

Blinds felt with or without V-cut

Optional extra layer Fabric, Rough, Trevira CS+ | CS, Revive 1, Revive 2, Terra, Clara 2, Remix 2, Hero, Tonus 4, Tonus Meadow, Memory 2 or Matrix

(extra layer not possible for V-cut)

Multicolour (front & back different colour)

Wheels (4pcs)

...

BuzziBlinds Arch

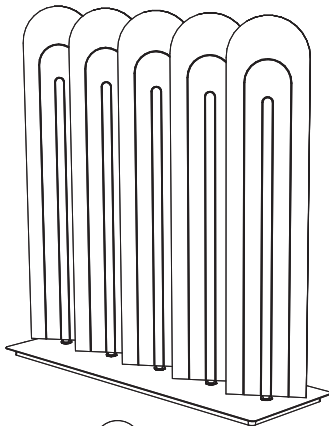

Arch
Front - Back

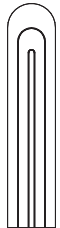

Arch V-cut lines 1
Front - Back

🏷️ M | L

Baseplate: powder coated metal

🌲 Blinds: core aluminium
BuzziFelt cover

M: H 155 cm, W 149 cm, D 49 cm
H 61.02", W 58.66", D 19.29"

✂️

L: H 190 cm, W 149 cm, D 49 cm
H 74.80", W 58.66", D 19.29"

Baseplate colour in black (RAL 9005) or white (RAL 9010)

Blinds felt with or without V-cut

Optional extra layer Fabric, Rough, Trevira CS+ | CS, Revive 1, Revive 2, Terra, Clara 2, Remix 2, Hero, Tonus 4, Tonus Meadow, Memory 2 or Matrix

(extra layer not possible for V-cut)

Multicolour (front & back different colour)

Wheels (4pcs)

...

Overview

BuzziBlinds Straight M|L



Straight
Front

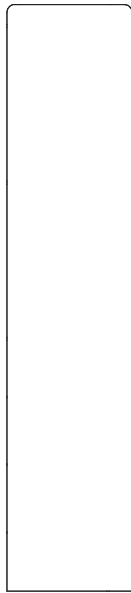

Straight
Back

M: H 150 cm W 32 cm L: H 185 cm W 32 cm
H 59.06" W 12.60" H 72.83" W 12.60"

BuzziBlinds Straight V-cut M|L

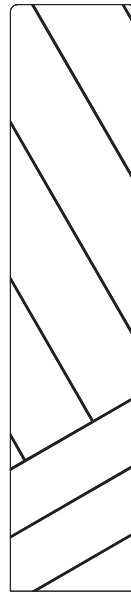

Straight V-cut lines 1
Front

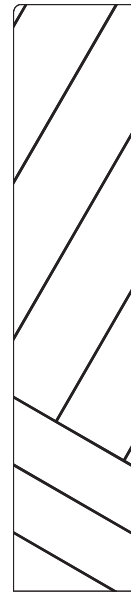

Straight V-cut lines 1
Back

M: H 150 cm W 32 cm L: H 185 cm W 32 cm
H 59.06" W 12.60" H 72.83" W 12.60"

BuzziBlinds Wedge M|L



Wedge
Front



Wedge
Back

M: H 150 cm W 32 cm L: H 185 cm W 32 cm
H 59.06" W 12.60" H 72.83" W 12.60"

BuzziBlinds Wedge V-cut M|L



Wedge V-cut lines 1
Front

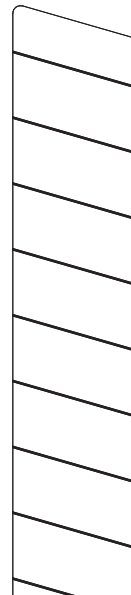

Wedge V-cut lines 1
Back

M: H 150 cm W 32 cm L: H 185 cm W 32 cm
H 59.06" W 12.60" H 72.83" W 12.60"

BuzziBlinds Beach M|L

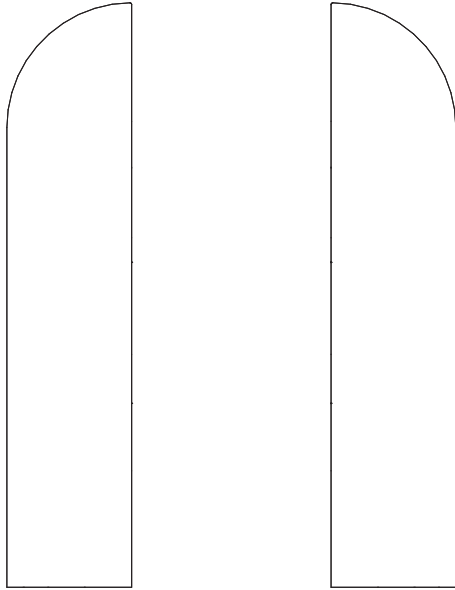

Beach
Front

Beach
Back

M: H 150 cm W 32 cm L: H 185 cm W 32 cm
H 59.06" W 12.60" H 72.83" W 12.60"

BuzziBlinds Beach V-cut M|L

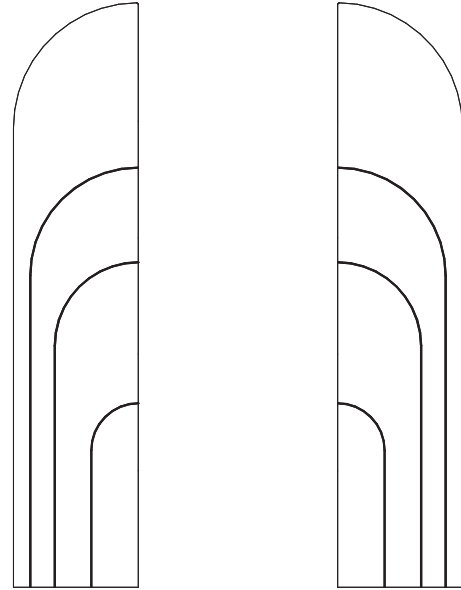

Beach V-cut lines 1
Front

Beach V-cut lines 1
Back

M: H 150 cm W 32 cm L: H 185 cm W 32 cm
H 59.06" W 12.60" H 72.83" W 12.59"

BuzziBlinds Arch M|L

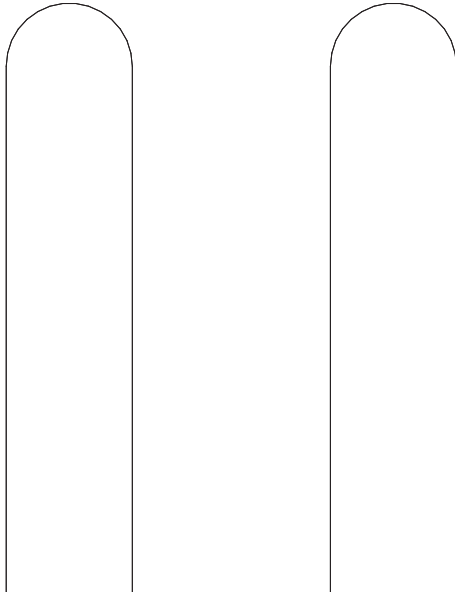

Arch
Front

Arch
Back

M: H 150 cm W 32 cm L: H 185 cm W 32 cm
H 59.06" W 12.60" H 72.83" W 12.60"

BuzziBlinds Arch V-cut M|L

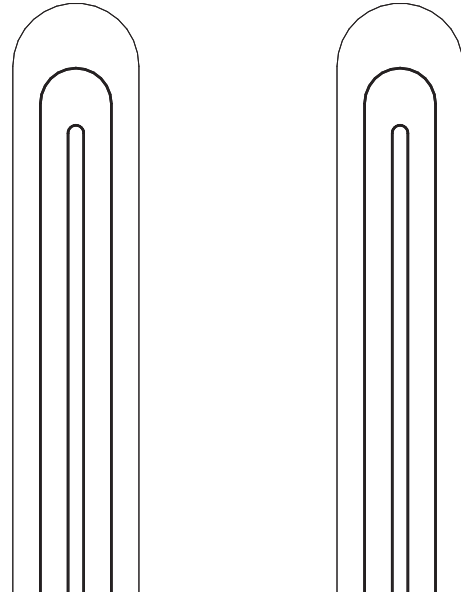

Arch V-cut lines 1
Front

Arch V-cut lines 1
Back

M: H 150 cm W 32 cm L: H 185 cm W 32 cm
H 59.06" W 12.60" H 72.83" W 12.60"

Fabrics

Fabric

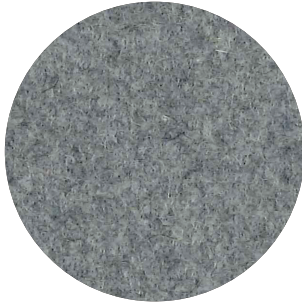

Category A

Composition 70% Recycled Wool, 25% Recycled Polyacryl,
5% Recycled Other Fabrics

Weight 405 g/m² | 11.94 oz/yd²

Abrasion resistance 40.000 Martindale, 50,000 Wyzenbeek

Flammability EU: EN 1021.1/2006 | BS EN 1021.1/2006 (cigarette).
EN 1021.2/2006 | BS EN 1021.2/2006 (match)
USA: CAL TB 117 | ASTM E84 CLASS A

Fastness to light EU 4 | USA 4

Fastness to rubbing EU: Wet 3-4 | Dry 4-5

Fastness to crocking USA: Wet 5 | Dry 5



Rough



Category A

Composition 100% Polyacryl

Weight 456 g/m² | 13.45 oz/yd²

Abrasion resistance 40.000 Martindale

Flammability EU: EN 1021.1/2006 | BS EN 1021.1/2006 (cigarette)

Fastness to light EU: 5

Fastness to rubbing EU: Wet: 3 | Dry: 3



Trevira CS+ | CS

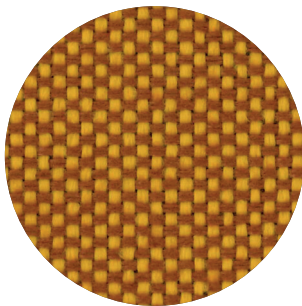

Category A

Weight 420 g/m² | 12.39 oz/yd²

Composition 100% Polyester, Trevira CS

Abrasion resistance 100.000 Martindale, 90,000 Wyzenbeek

Flammability BS 5852 part II: CRIB 5 | BS 7176 Medium Hazard
USA: CAL TB 117 | M1 | B1 | EN 1021/1-2 | C1 |
EN 1021/1-2
IMO Res. A652 (16)

Fastness to light EU: 6 | USA 5

Fastness to rubbing EU: Wet 4-5 | Dry 4-5

Fastness to crocking USA: Wet 5 | Dry 5



Revive 1

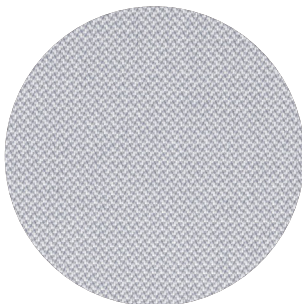

Category A

Composition 100% recycled polyester FR

Weight 430 g/lin.m

Abrasion resistance 60.000 Martindale rubs, EN ISO 12947

Flammability EN 1021-1/2 | DIN 4102 B1 | Önorm B1/Q1
UNI 9175 1IM | US Cal. Tech. Bull. 117
IMO A.652 (16)

Fastness to light Note 5-7, ISO 105-B02

Fastness to rubbing (ISO) dry 5, wet 4-5

Pilling Note 4-5, EN ISO 12945



kvadrat

Revive 2

kvadrat

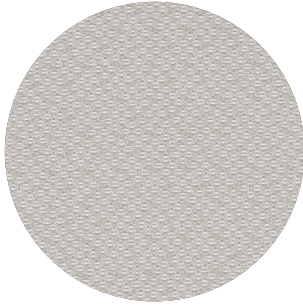

Category A

Composition 100% recycled polyester FR

Weight 420 g/lin.m

Abrasion resistance 45.000 Martindale rubs, EN ISO 12947

Flammability EN 1021-1/2 | DIN 4102 B1 | Önorm B1/Q1
UNI 9175 1IM | US Cal. Tech. Bull. 117
IMO A.652 (16)

Fastness to light Note 5-7, ISO 105-B02

Fastness to rubbing (ISO) dry 5, wet 4-5

Pilling Note 4-5, EN ISO 12945



Terra

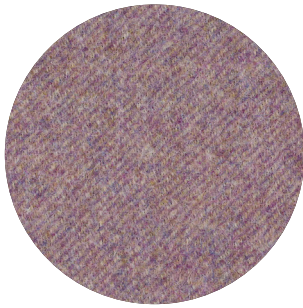

Category B

Composition 100% Pure New Wool

Weight 370 g/m² | 10.91 oz/yd²

Abrasion resistance 40.000 Martindale, 25,000 Wyzenbeek

Flammability EU: BS5852 CRIB 5 | BS5867 PART 2 : 2008 : TYPE B
EN 1021.2/2006 | USA: CAL TB 117

Fastness to light EU 5 | USA 5

Fastness to rubbing EU: Wet 4 | Dry 4

Fastness to crocking USA: Wet 4 | Dry 4



Clara 2

kvadrat

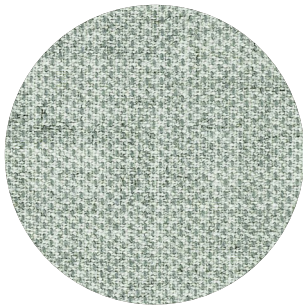

Category B

Composition 92% new wool, 8% nylon

Weight 400 g/lin.m

Abrasion resistance 80.000 Martindale rubs, EN ISO 12947

Flammability EN 1021-1/2 | BS 5852, ignition source 2-3 | DIN 4102 B2
NF D 60 013 | UNI 9175 1IM | US Cal. Tech. Bull. 117, Sec. E
NFPA 260 | IMO A.652(16)

Fastness to light Note 5-7, ISO 105-B02

Fastness to rubbing (ISO) dry 4-5, wet 4

Pilling Note 4, EN ISO 12945



Remix 2

kvadrat



Category B

Composition 90% new wool, 10% nylon

Weight 415 g/lin.m

Abrasion resistance 100.000 Martindale rubs, EN ISO 12947

Flammability EN 1021-1/2 | BS 5852 part 1
Önorm B1/Q1 | NF D 60 013 | UNI 9175, 1IM
AS/NZS 1530.3 | Cal. Tech. Bull. 117-2013
NFPA 260 | IMO FTP Code 2010:Part 8

Fastness to light Note 5-7, ISO 105-B02

Fastness to rubbing (ISO) dry 4-5, wet 4

Pilling Note 4, EN ISO 12945



Hero

kvadrat

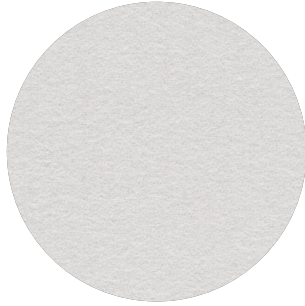

Category C

Composition 96% new wool, 4% nylon

Weight 580 g/lin.m

Abrasion resistance 45.000 Martindale rubs, EN ISO 12947

Flammability EN 1021-1/2 | DIN 4102 B2 | NF D 60 013
UNI 9175 11M | US Cal. Bull. 117-2013 | NFPA 260
IMO A.652 (16)

Fastness to light Note 5-6, ISO 105-B02

Fastness to rubbing (ISO) dry 4-5, wet 4-5

Pilling Note 3-4, EN ISO 12945



Tonus 4

kvadrat

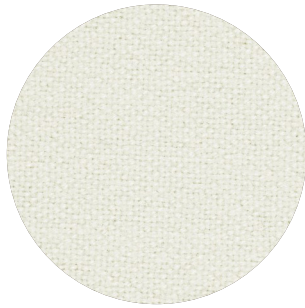

Category D

Composition 90% new wool, 10% Helanca

Weight 665 g/lin.m

Abrasion resistance 100.000 Martindale rubs, EN ISO 12947

Flammability EN 1021-1/2 | BS 5852 part 1 | DIN 4102 B2
Önorm B1/Q1 | NF D 60 013 | UNI 9175 11M
US Cal. Bull. 117-2013 | NFPA 260 | IMO A.652 (16)

Fastness to light Note 5-7, ISO 105-B02

Fastness to rubbing (ISO) dry 3-5, wet 3-5

Pilling Note 3, EN ISO 12945



Tonus Meadow

kvadrat



Category D

Composition 90% new wool, 10% Helanca

Weight 665 g/lin.m

Abrasion resistance 100.000 Martindale rubs, EN ISO 12947

Flammability EN 1021-1/2 | BS 5852 part 1 | DIN 4102 B2
Önorm B1/Q1 | NF D 60 013 | UNI 9175 11M
US Cal. Bull. 117-2013 | NFPA 260 | IMO A.652 (16)

Fastness to light Note 5-7, ISO 105-B02

Fastness to rubbing (ISO) dry 4-5, wet 4

Pilling Note 3, EN ISO 12945



Memory 2

kvadrat

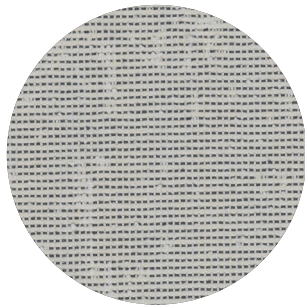

Category E

Composition 100% Trevira CS

Weight 700 g/lin.m

Abrasion resistance

35.000 rubs acc. to the Martindale method, EN ISO 12947

Flammability EN 1021-1/2 | DIN 4102 B1 | Önorm B1/Q1
NF D 60 013 | NF P 92 507 M1 | UNI 9175 11M
UNI 9177 classe 1 | US Cal. Tech. Bull. 117
IMO A.652 (16)

Fastness to light Note 5-8, ISO 105-B02

Fastness to rubbing (ISO) dry 4-5, wet 4-5

Pilling Note 4, EN ISO 12945



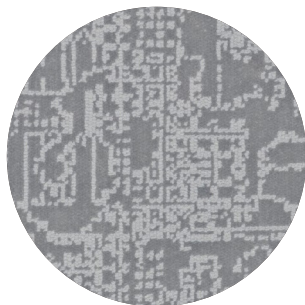

Category F

Composition 100% Trevira CS

Weight 760 g/lin.m

Abrasion resistance

App. 60.000 rubs acc. to the Martindale method, EN ISO 12947

Flammability EN 1021-1/2 | BS 5852 crib 5 | BS 5867 part 2 type B

DIN 4102 B1 | Önorm B1/Q1 | NF D 60 013

UNI 9175 1IM | US Cal. Tech. Bull. 117 | NFPA 701

IMO A.652 (16)

Fastness to light Note 5-7, ISO 105-B02

Fastness to rubbing (ISO) dry 4-5, wet 4-5

Pilling Note 4, EN ISO 12945



Dimensions

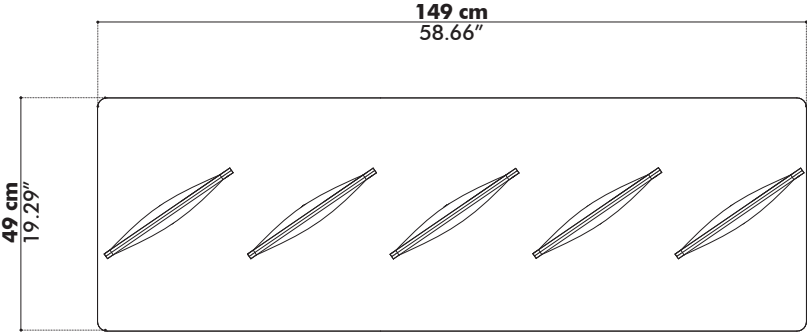
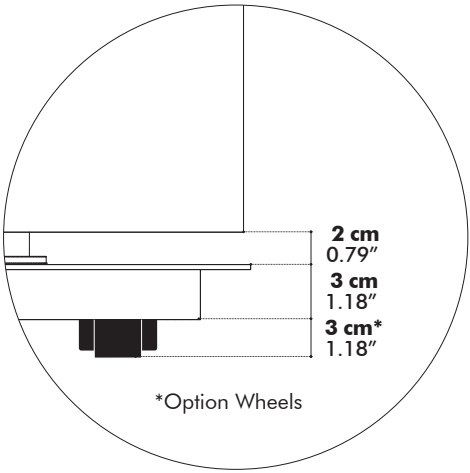
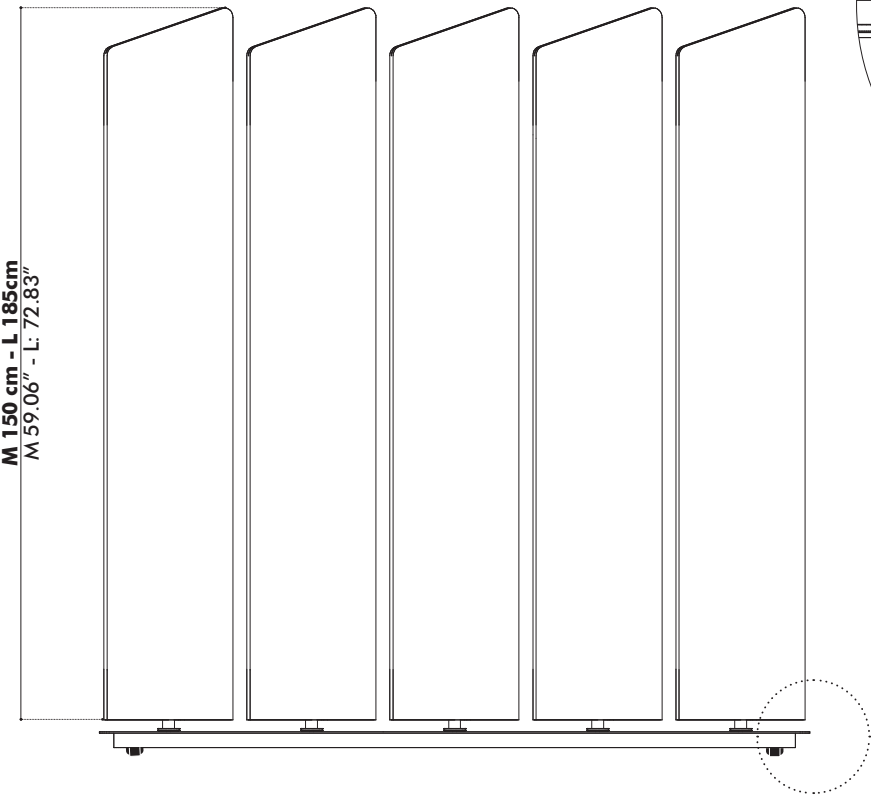

BuzziBlinds Baseplate Regular

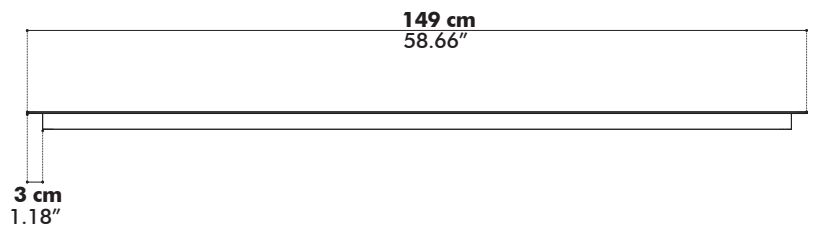
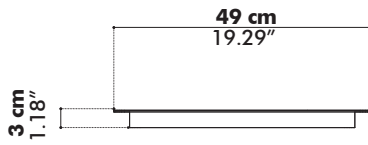
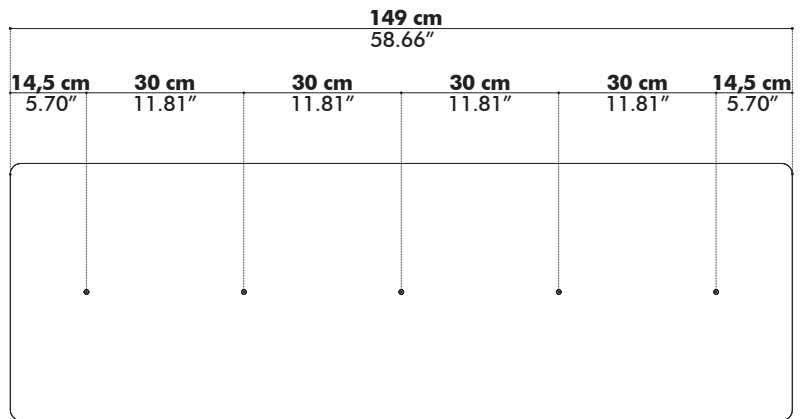

Acoustics

Equivalent sound absorption area in m² per object

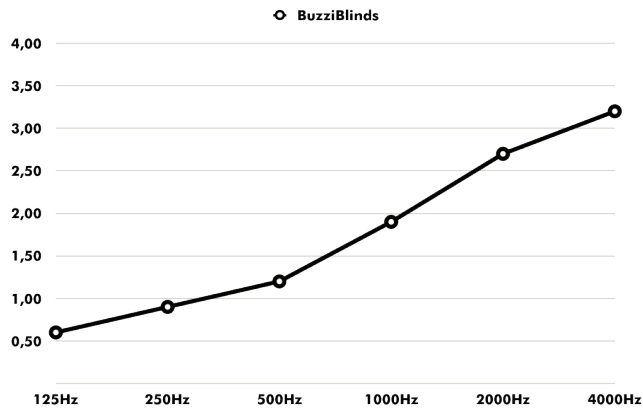

Hz	Aeq/m ²
125	0.6
250	0.9
500	1.2
1000	1.9
2000	2.7
4000	3.2