



BuzziFalls

Product Specification Sheet

Discover all insights on BuzziFalls.
Acoustical room dividers offering you a
variety of patterns, sizes and colors to
organize your space.

•BUZZI
SPACE





www.buzzi.space

A playful solution to regulate sounds

To divide a space and create some privacy, the BuzziFalls are a new playful variation in our acoustic solutions gamma. These strips are made out of BuzziFelt with cut out shapes in various patterns, for example falling leaves. A playful solution to regulate sounds and create smaller areas in big spaces.

Design by Sas Adriaenssens

General

-  Pattern: Alhambra, Birch, Leaves, Orient, Pebbles, Plain, Rain, Royal
-  Skylines: Atlanta, Chicago, London, Paris, New York, San Francisco (set of 3 panels)
Monocolor | Bicolor
- 2 layers of BuzziFelt
-  Profile metal powder coated black | RAL 9005 matt or metal powder coated White | RAL 9010 matt
Pendant black steel cable for black profile | silver steel cable for white profile
-  BuzziFelt Pattern: 220 cm x 80 cm | 86.61" x 31.50" or 250 x 80 cm | 98.42" x 31.50"
Skylines 100 cm x 80 cm | 39.37" x 31.50" or 150 cm x 80 cm | 59.05" x 31.50"
or 220 cm x 80 cm | 86.61" x 31.50" or 250 cm x 80 cm | 98.42" x 31.50"
- BuzziFall wall | Ceiling mounted or BuzziFall Suspended (cable 2 m | 78.74" or 5 m | 196.85")
-  Possibility to connect several falls
Rail (1 | 2 | 3 falls in 1 rail)
Extra rail for extension

Acoustics



Absorption



Diffusion

Content

Patterns	3
Fixing systems	7
Option Rail	9
Dimensions	10
Acoustics	12

Patterns

Alhambra

250 cm | 98.42" 220 cm | 86.61"
 3,1 kg | 6.83lbs 2,8 kg | 6.17lbs

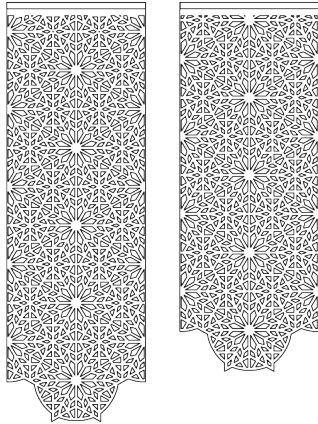

Royal

250 cm | 98.42" 220 cm | 86.61"
 3,6 kg | 8.00lbs 3,2 kg | 7.05lbs

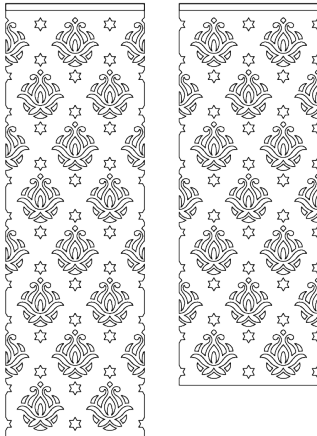

Birch

250 cm | 98.42" 220 cm | 86.61"
 2,6 kg | 5.70lbs 2,5 kg | 5.51lbs

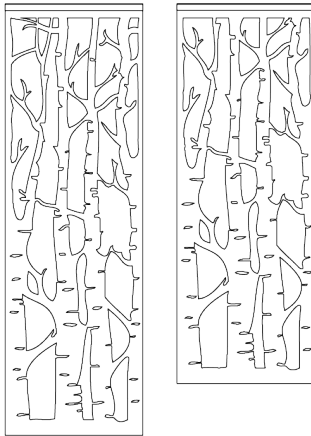

Leaves

250 cm | 98.42" 220 cm | 86.61"
 3,1 kg | 6.83lbs 2,8 kg | 6.17lbs

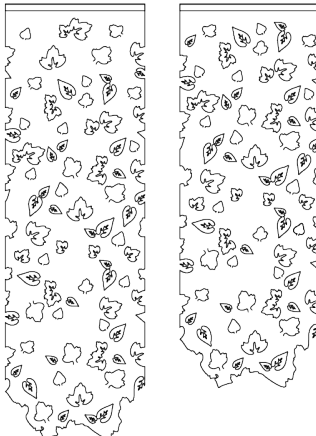

Orient

250 cm | 98.42" 220 cm | 86.61"
 3,7 kg | 8.16lbs 3,3 kg | 7.27lbs

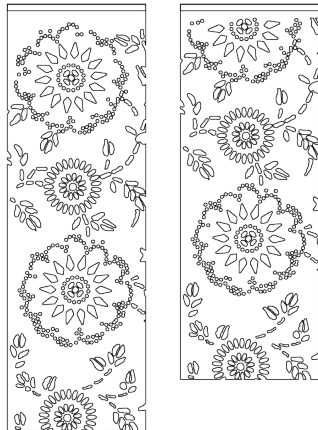

Rain

250 cm | 98.42" 220 cm | 86.61"
 3,9 kg | 8.63lbs 3,4 kg | 7.48lbs

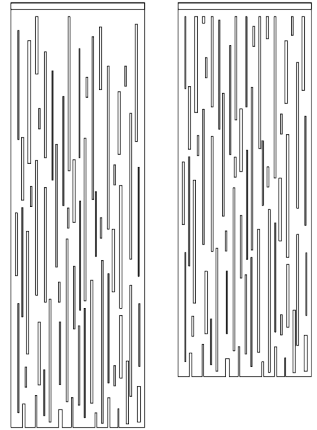

Pebbles

250 cm | 98.42" 220 cm | 86.61"
 1,7 kg | 3.74lbs 1,5 kg | 3.30lbs

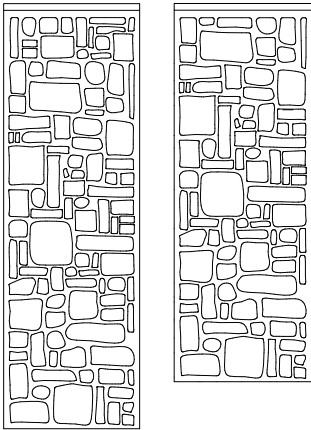

Plain

250 cm | 98.42" 220 cm | 86.61"
 4,5 kg | 9.92lbs 4 kg | 8.81lbs

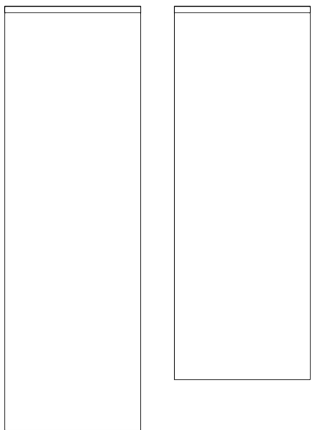

Skylines

New York

250 cm | 98.42"

4,2 kg | 9.26 lbs 4,0 kg | 8.80 lbs 4,0 kg | 8.80 lbs

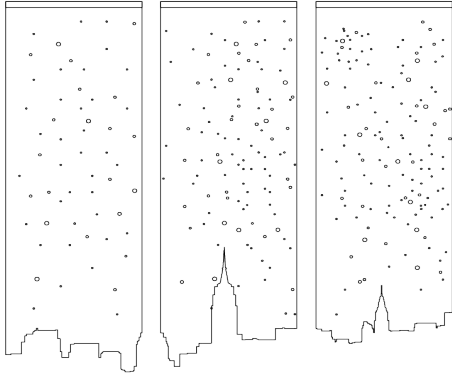

220 cm | 86.61"

3,7 kg | 8.1 lbs 3,5 kg | 7.71 lbs 3,5 kg | 7.71 lbs

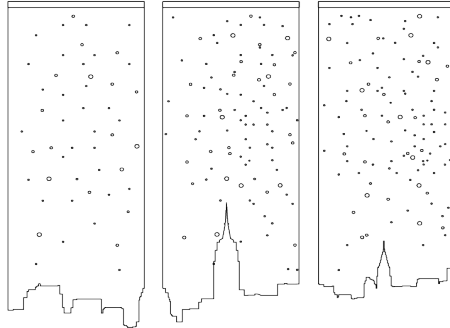

150 cm | 59.05"

2,5 kg | 5.59 lbs 2,3 kg | 5.15 lbs 2,3 kg | 5.15 lbs

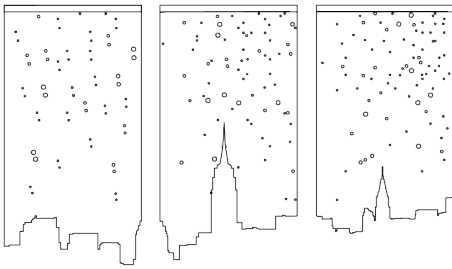

100 cm | 39.37"

1,7 kg | 3.76 lbs 1,5 kg | 3.32 lbs 1,5 kg | 3.32 lbs

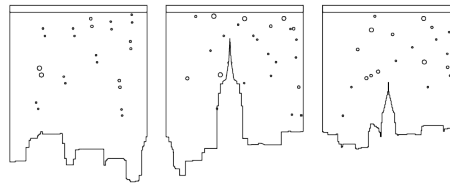

Chicago

250 cm | 98.42"

4,2 kg | 9.26 lbs 3,9 kg | 8.60 lbs 4,1 kg | 9.03 lbs

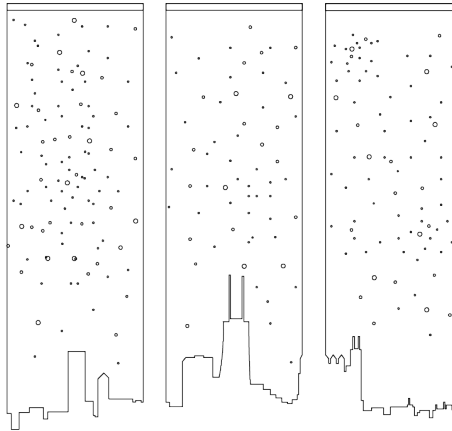

220 cm | 86.61"

3,9 kg | 8.60 lbs 3,5 kg | 7.71 lbs 3,6 kg | 8.16 lbs

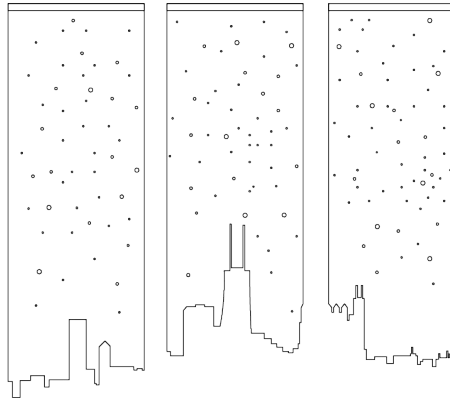

150 cm | 59.05"

2,5 kg | 5.59 lbs 2,2 kg | 4.93 lbs 2,4 kg | 5.37 lbs

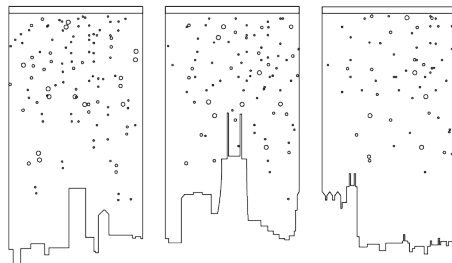

100 cm | 39.37"

1,7 kg | 3.76 lbs 1,4 kg | 3.10 lbs 1,6 kg | 3.54 lbs

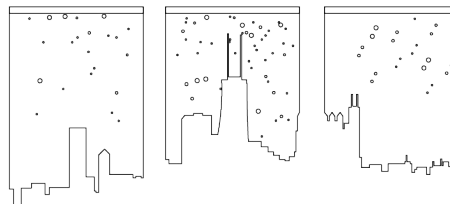

Atlanta

250 cm | 98.42"
4,3 kg | 9.47 lbs 4,1 kg | 9.03 lbs 4,0 kg | 8.81 lbs

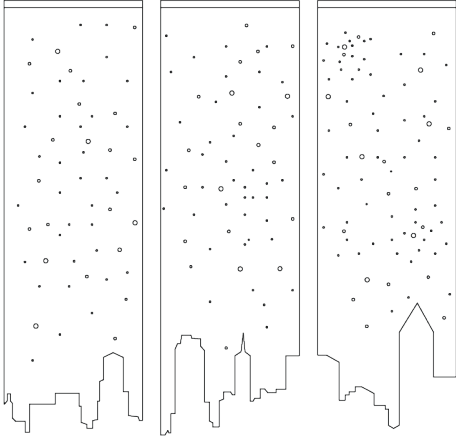

220 cm | 86.61"
3,8 kg | 8.37 lbs 3,6 kg | 8.16 lbs 3,5 kg | 7.71 lbs

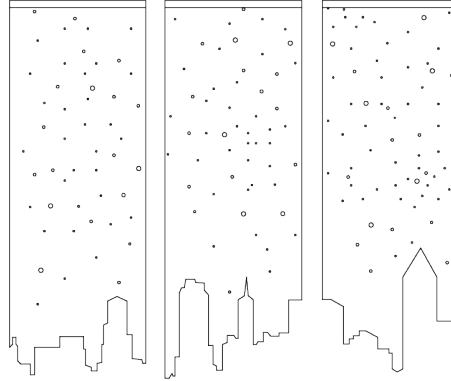

150 cm | 59.05"
2,6 kg | 5.82 lbs 2,5 kg | 5.59 lbs 2,4 kg | 5.37 lbs

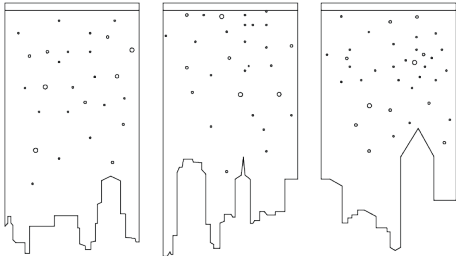

100 cm | 39.37"
1,7 kg | 3.76 lbs 1,6 kg | 3.54 lbs 1,6 kg | 3.54 lbs

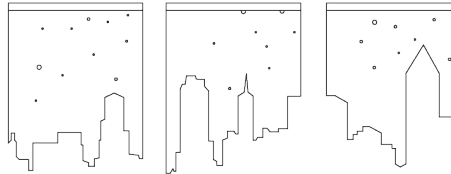

San Francisco

250 cm | 98.42"
4,3 kg | 9.47 lbs 4,2 kg | 9.25 lbs 4 kg | 8.81 lbs

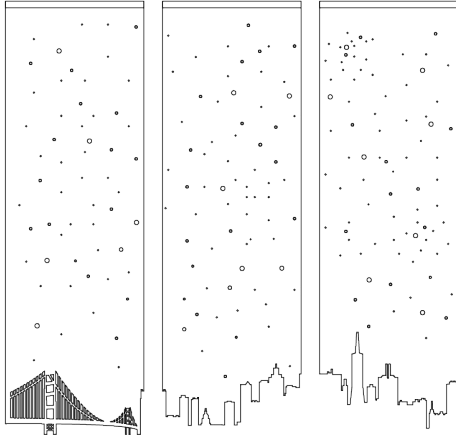

220 cm | 86.61"
3,9 kg | 8.59 lbs 3,7 kg | 8.15 lbs 3,5 kg | 7.71 lbs

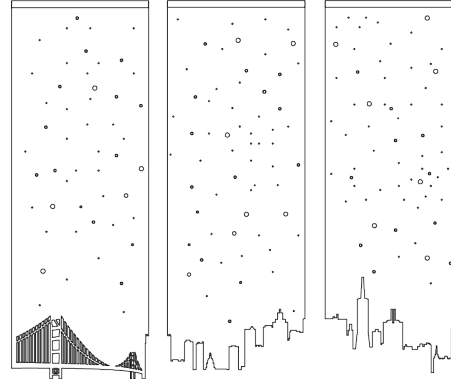

150 cm | 59.05"
2,6 kg | 5.82 lbs 2,5 kg | 5.59 lbs 2,3 kg | 5.15 lbs

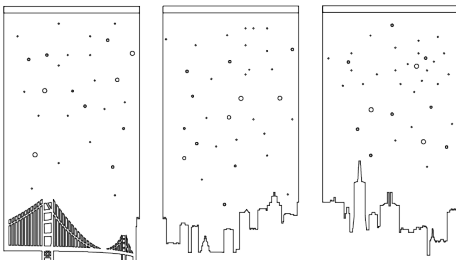

100 cm | 39.37"
1,8 kg | 3.99 lbs 1,7 kg | 3.76 lbs 1,51 kg | 3.32 lbs

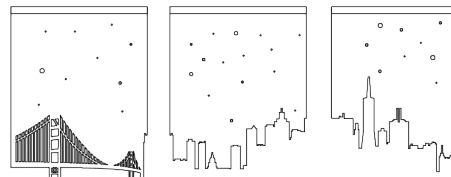

London

250 cm | 98.42"

4,2 kg | 9.25 lbs 4,2 kg | 9.25 lbs 4,3 kg | 9.47 lbs

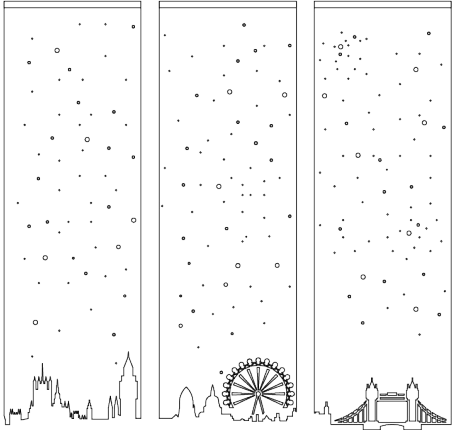

220 cm | 86.61"

3,7 kg | 8.15 lbs 3,7 kg | 8.15 lbs 3,8 kg | 8.37 lbs

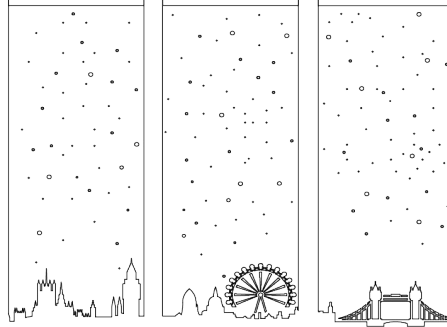

150 cm | 59.05"

2,5 kg | 5.59 lbs 2,5 kg | 5.59 lbs 2,6 kg | 5.82 lbs

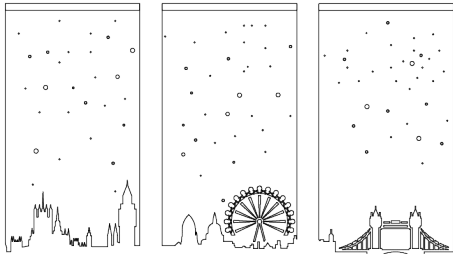

100 cm | 39.37"

1,7 kg | 3.76 lbs 1,7 kg | 3.76 lbs 1,8 kg | 3.99 lbs

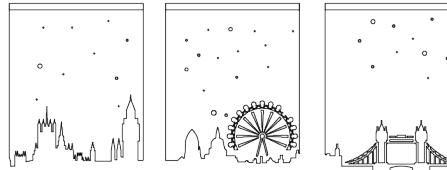

Paris

250 cm | 98.42"

4,4 kg | 9.70 lbs 4,2 kg | 9.25 lbs 4,2 kg | 9.25 lbs

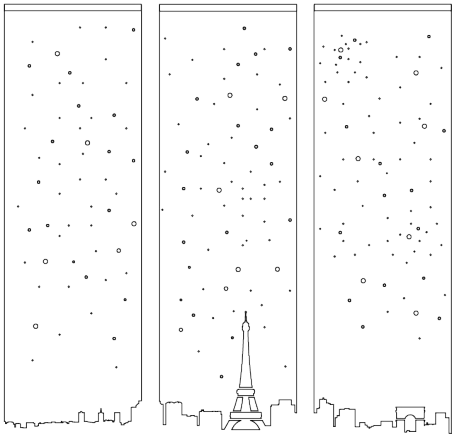

220 cm | 86.61"

3,9 kg | 8.59 lbs 3,8 kg | 8.37 lbs 3,8 kg | 8.37 lbs

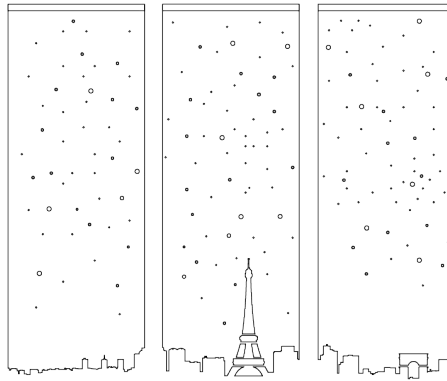

150 cm | 59.05"

2,7 kg | 6.04 lbs 2,5 kg | 5.59 lbs 2,5 kg | 5.59 lbs

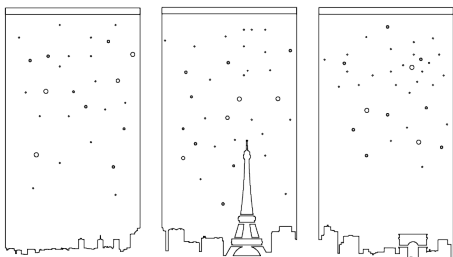

100 cm | 39.37"

1,9 kg | 4.21 lbs 1,7 kg | 3.76 lbs 1,7 kg | 3.76 lbs

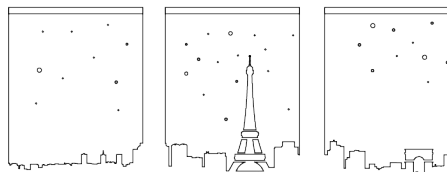

Fixing Systems

BuzziFalls Suspended

Profile black or white

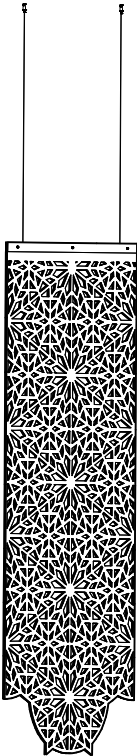

BuzziFalls Suspended > 1

Profile black or white

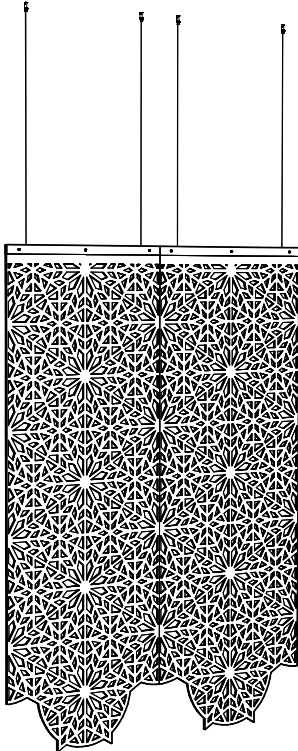

BuzziFalls Ceiling Mounted

Profile black or white

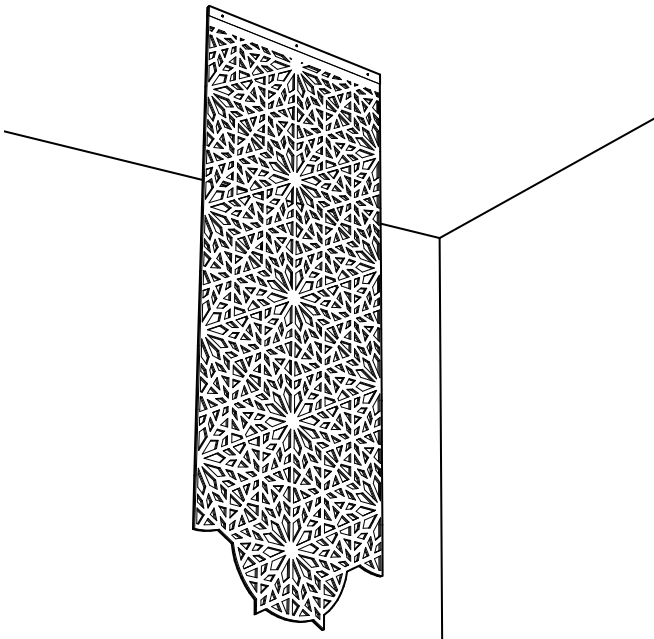

BuzziFalls Ceiling Mounted > 1

Profile black or white

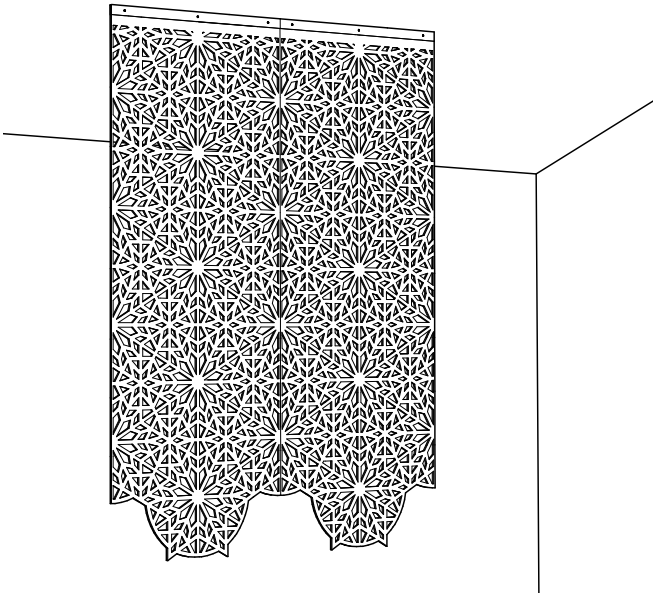

BuzziFalls Mounted Wall

Profile black or white

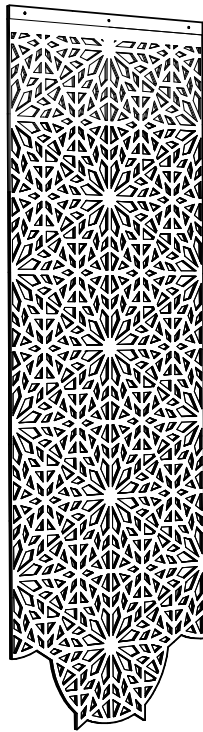

BuzziFalls Wall > 1

Profile black or white

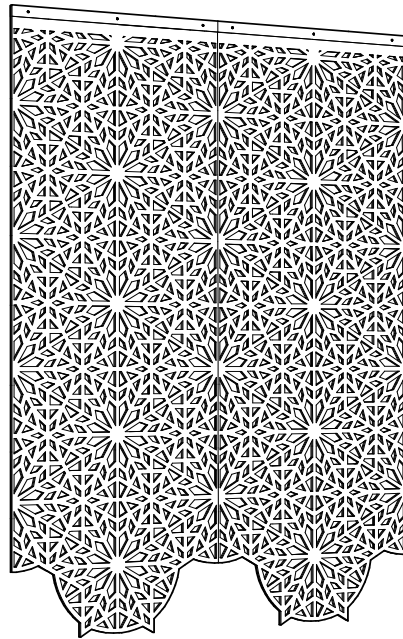

BuzziFalls Rail Suspended

Profile black or white

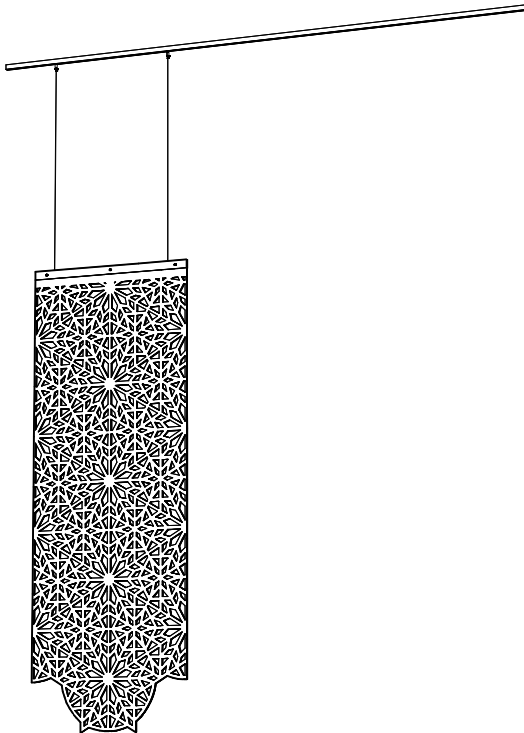

BuzziFalls Rail Mounted

Profile black or white

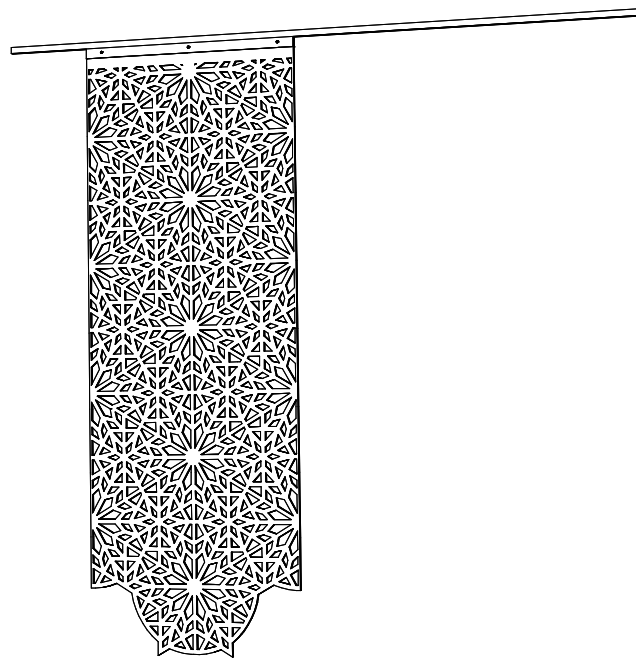

Option: Rail

The rail can be extended by buying a extra rail

BuzziFalls Rail Suspended

Profile black or white

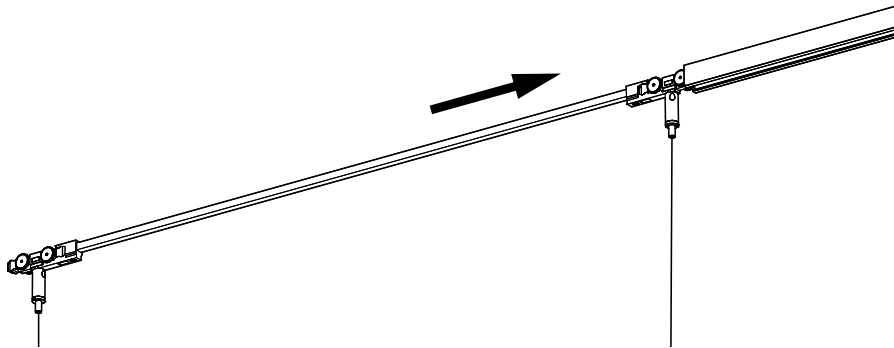

BuzziFalls Rail Mounted

Profile black or white

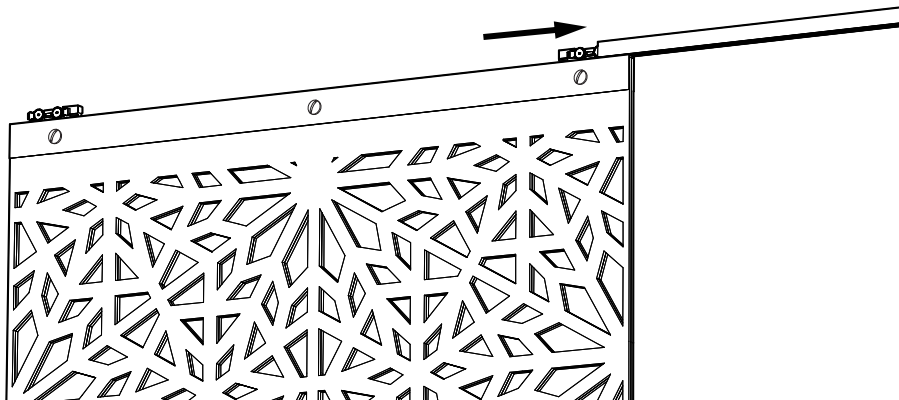

Rail

Black or white, length 3,20 m | 125,98".

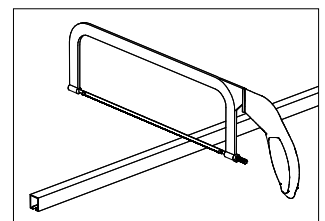
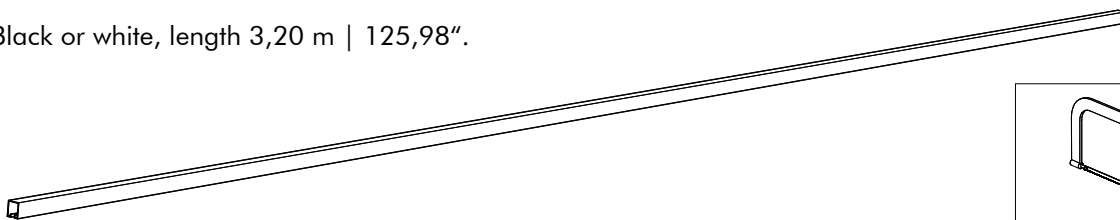

End cap

Stop end black or white included

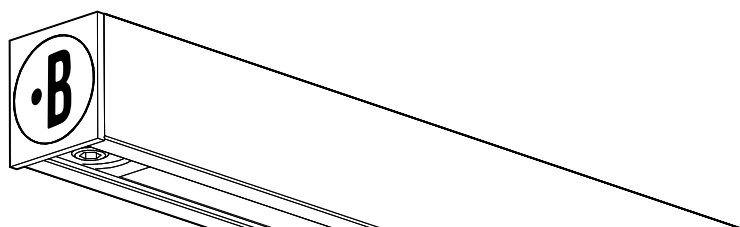

Dimensions

Falls Felt

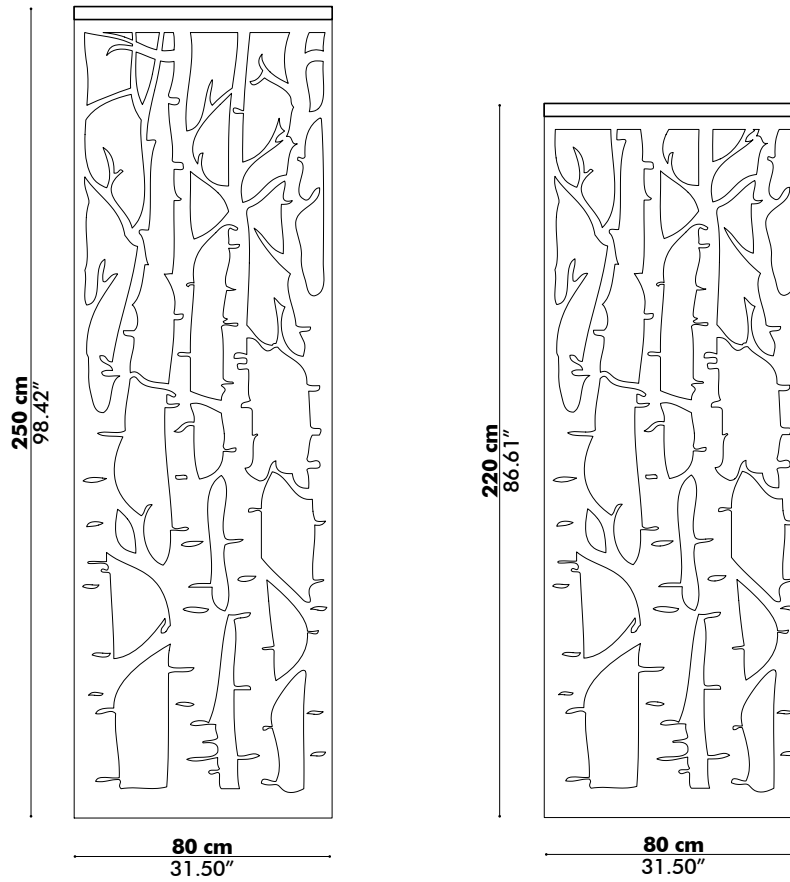

Metal Profile

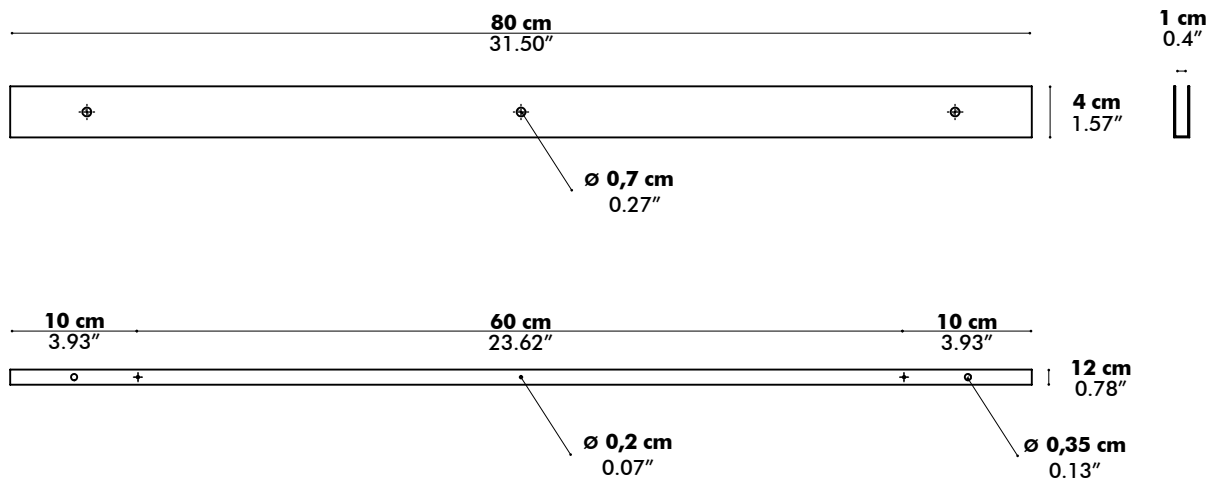

Alu Rail

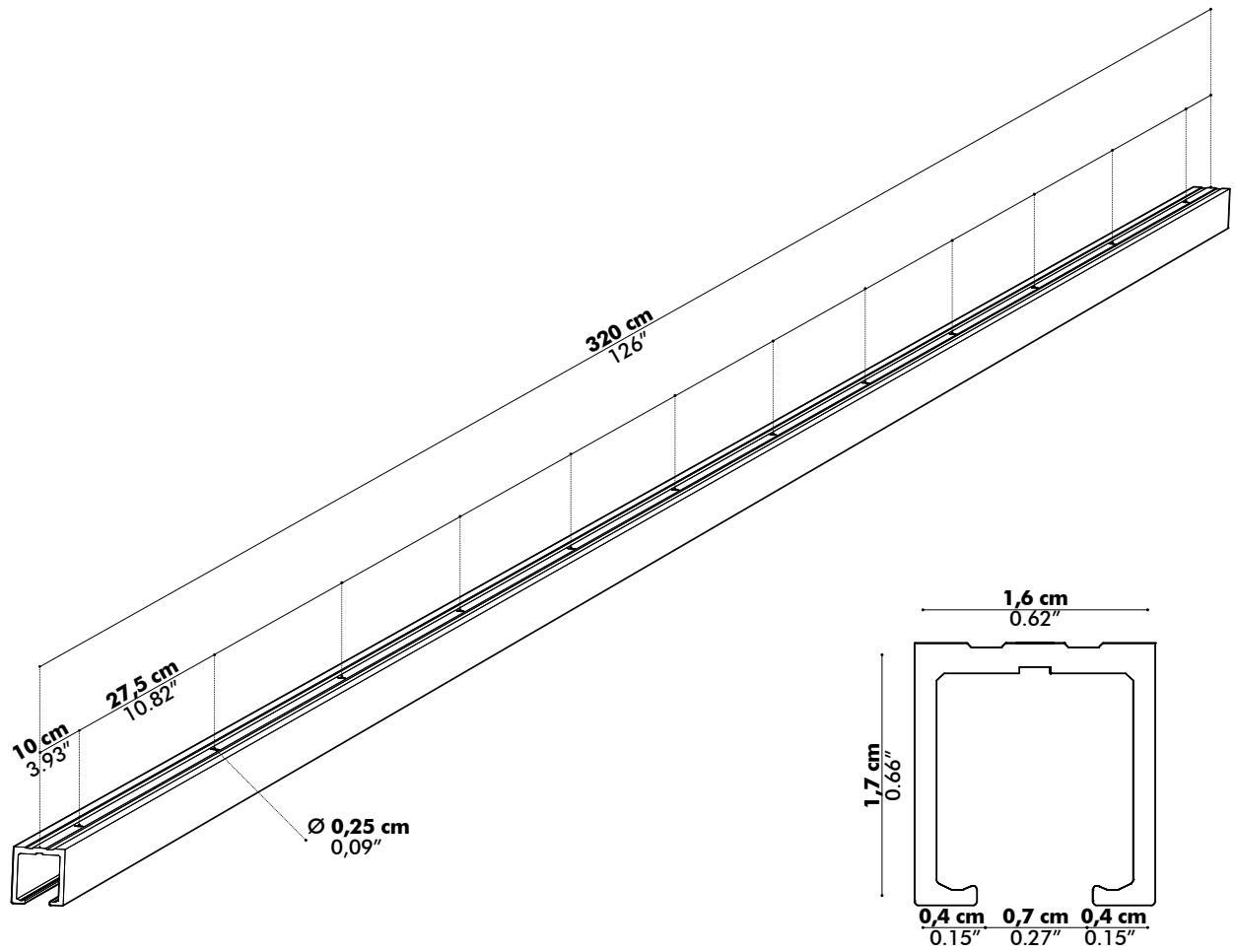

Acoustics

BuzziFalls Alhambra | Birch

Equivalent sound absorption area in m² per object

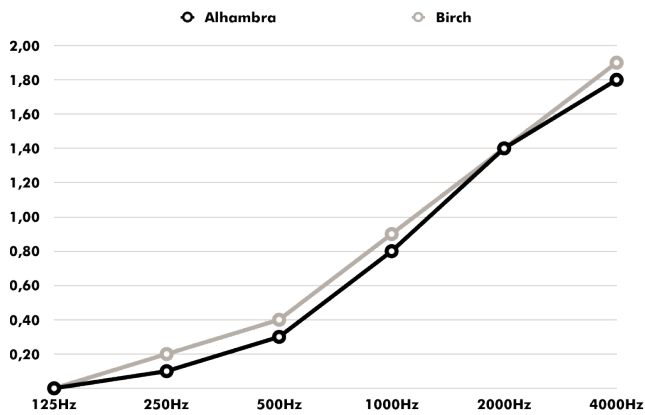

Hz	Alhambra Aeq/m ²	Birch Aeq/m ²
125	0.0	0.0
250	0.1	0.2
500	0.3	0.4
1000	0.8	0.9
2000	1.4	1.4
4000	1.8	1.9