

Movinord

Office Concept

TEC

•

New data management technologies have revolutionised the way we conceive an office.

Yesteryear we sought privacy for each one of the posts, now we value configurations that favour communication, the personal touch, and the interchange of ideas among the components of the group.

We have conceived the Tec programme from this perspective, to provide a flexible system for the workplace that allows different configurations depending on the needs of each personal case, from individual workstations, doubles, quadruples or the assimilation of an open plan work space that adapts to the needs of the users at that moment in time and the peculiarities of the tasks they must accomplish, be it reflection, dialogue or meeting.

••

Las nuevas tecnologías de la información, han modificado significativamente el modo de concebir una oficina.

Si en tiempos anteriores se buscaba la privacidad de cada uno de los usuarios, actualmente se valoran las implantaciones que favorezcan la comunicación, el trato personal y el intercambio de ideas entre los componentes del grupo.

Desde esta perspectiva se ha concebido el programa Tec, para facilitar un sistema abierto de lugar de trabajo que permite diferentes configuraciones según las necesidades de cada caso, desde puestos individuales, dobles, cuádruples o la asimilación de un espacio continuo que se adapta a los usuarios de cada momento y a las particularidades de las tareas que deban realizar, ya sean de reflexión de diálogo o de reunión.

••

Die neuen Informationstechnologien haben das, was wir unter einem Büro verstehen, nachhaltig verändert.

In früheren Zeiten suchte man nach Privatraum für jeden einzelnen Benutzer, aber heute legt man auf Einrichtungen, die Kommunikation, persönliche Behandlung und Ideenaustausch zwischen den Mitarbeitern eines Teams fördern, besonderen Wert.

Aus dieser Perspektive heraus, ist das Programm Tec entwickelt worden, welches ein offenes System für den Arbeitsplatz bietet und das verschiedene Kombinationen, angepasst an die jeweiligen Bedürfnisse, erlaubt. So können zum Beispiel individuelle, doppelte oder 4-er Arbeitsplätze entstehen, oder der angrenzende Raum kann in jedem Fall an den Benutzer und an die Besonderheiten der auszuführenden Aufgaben, auch wenn es sich dabei um Reflexion, Dialog oder Versammlung handelt, angepasst werden.







INDIVIDUAL DESK

•

This is the most elementary Tec system, covering the basic requirements of an individual work station.

The desk top can be extended by fitting wings on either of the sides and can be made more functional thanks to the cable management options and accessories available.

••

Es la solución más elemental de Tec que da respuesta a las necesidades básicas de un puesto de trabajo individual.

La superficie de la mesa puede ampliarse con la colocación de un ala en cualquiera de los laterales y su funcionalidad incrementada gracias a las opciones de electrificación y complementos disponibles.

••

Dies ist die elementarste Lösung von Tec, die die grundlegenden Erfordernisse an einen Einzel-Arbeitsplatz erfüllt.

Die Tischoberfläche lässt sich durch den Anbau eines Flügels an einer Seite vergrößern, und die Funktionalität kann durch die angebotenen Kabelführungsoptionen und Accessoires erweitert werden.



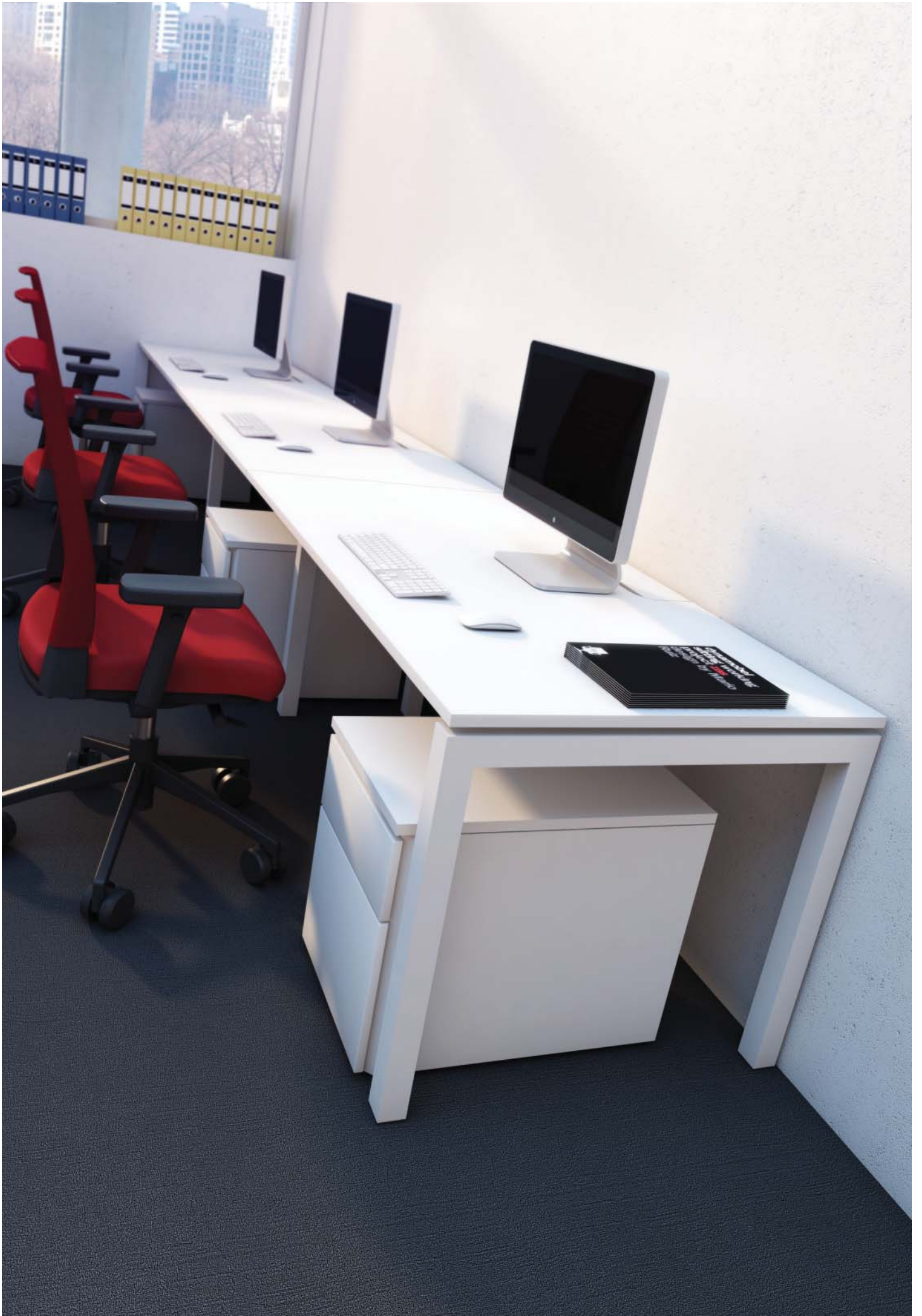

GROUPED ALIGNED DESKS

• Individual desks can be joined together in the Tec programme to form rows, a format suited to the layout of call centres, reception areas, training areas and even meeting areas in which the desks are set out around an open space.

The desks are joined through a shared, inset leg, a component that does not make the desks any less functional and lowers the overall cost of the assembly.

•• El programa Tec permite la unión de mesas individuales bajo un concepto de agrupación lineal, una posibilidad de formación que favorece la realización de call centers, zonas de recepción, zonas de formación e incluso la creación de zonas de reunión donde las mesas se disponen en torno a un espacio circular.

La unión de las mesas se hace mediante una pata compartida y remitida, un elemento que no resta funcionalidad y que abarata el proyecto global de la instalación.

••• Das Tec-Programm ermöglicht die Verbindung von einzelnen Arbeitsplätzen nach einem linearen Anordnungskonzept, das die Gestaltung von Call-Center, Empfangsbereichen, Fortbildungsbereichen und selbst Besprechungsbereichen ermöglicht, in denen die Tische kreisförmig angeordnet werden.

Die Verbindung der Tische erfolgt durch ein gemeinsames nach hinten versetztes Tischbein, das die Funktionalität beibehält und das Gesamtprojekt der Einrichtung kostengünstiger macht.

FACING DESK

•

There is a trend to make work areas more sociable environments, inspired, above all, by the need to optimise available space. There also exists a need to enhance interaction and communication between the members of a same department.

Tec was conceived as a means of encouraging team work and facilitating the creation of work stations grouped together and arranged face to face with different levels of privacy.

••

Existe una tendencia a socializar las áreas de trabajo, promovida, principalmente, por la optimización de los espacios disponibles. A esta circunstancia se añade la necesidad de incrementar la interacción y la comunicación entre las personas de un mismo departamento.

Tec nació con esta convicción, la de promover el trabajo en equipo y facilitar la implantación de puestos de trabajo agrupados enfrentados con diferentes niveles de privacidad.

••

Es besteht die Tendenz, Arbeitsbereiche zu kollektivieren und dadurch eine Optimierung der verfügbaren Räumlichkeiten zu erzielen. Dazu kommt noch die Notwendigkeit, die Kommunikation und Interaktion zwischen den Mitarbeitern einer Abteilung zu erleichtern.

Tec wurde mit dem Ziel entworfen, die Gruppenarbeit zu fördern und die Implantation von sich gegenüberliegenden Gruppenarbeitsplätzen mit unterschiedlichen Privatsphärengraden zu erleichtern.





FACING DESK PERSPEX FRONTAL PANEL

MESAS ENFRENTADAS PANEL DE METACRILATO • PERSPEX FRONTALES PANEEL FÜR DOPPELTISCH





Screen detail.
Détalle de panel.
Detail-Paneel.



FACING DESKS WITH SCREEN

MESAS ENFRENTADAS CON PANEL • FRONTALES PANEEL FÜR DOPPELTISCH





Left: Lacquered screen - Top: Upholstered screen.
 Izquierda: Panel lacado - Arriba: Panel tapizado.
 Links: Lackiert Paneel - Top: Gepolsterte Paneel.



Upholstered screen detail.
 Detalle de panel tapizado.
 Gepolsterte Paneel detail.



Laminated screen.
 Panel laminado.
 Laminat Paneel.

FACING DESK WITH PROFILE TEC 2

This version of the programme incorporates an aluminium extrusion flush to the desktop that allows us to fit screens and other accessories that optimise the workspace to the maximum.

This contribution facilitates the incorporation of the specific accessories that come with the range such as vertical elements and other Dynamobel complements.

We may choose between the different desk mounted screens in the programme:

- Side desk mounted screen
- Front desk mounted screen
- Technical desk mounted screen, that allows the fitting of organisation accessories.

Esta versión del programa que incorpora un perfil de aluminio a ras de tablero nos permite colocar paneles y diferentes accesorios optimizando al máximo el espacio de trabajo.

Esta prestación facilita la incorporación de elementos verticales tales como accesorios específicos de la gama y la colocación de complementos Dynamobel.

En esta versión del programa podemos escoger entre diferentes modelos de panel separador:

- Panel intermedio
- Panel anchura mesa
- Panel técnico, que permite la colocación de accesorios de organización.

Diese Version des Programms hat auf Höhe der Tischplatte ein Aluminiumprofil, das uns gestattet, Paneele und verschiedenes Zubehör anzubringen, um so den Arbeitsbereich optimal auszunützen zu können.

Diese Ausstattung erleichtert den Einsatz von vertikalen Elementen wie spezifisches Zubehör innerhalb der angebotenen Palette und den Einsatz von anderem Dynamobel- Zubehör.

Bei dieser Version des Programms stehen verschiedene Modelle von Trennpaneelen zur Auswahl:

- Zwischenpaneel
- Tischbreitenepaneel
- Organisationspaneel, das die Anbringung von Accessoires zur Organisation erlaubt.





WIRING EXIT



Aluminum flip up cover.
Tapa abatible aluminio frontal.
Frontale Klappe Aluminium.



Frontal sliding cover.
Tapa deslizante frontal.
Frontale Schiebeabdeckung.



Wiring exit and sliding top.
Pasacables y tablero desplazable.
Kabelausschuss und Schiebeplatte.



Laminated flip up cover and sliding top detail.
Tapa abatible frontal laminado y detalle tablero desplazable.
Frontale Klappe und Schiebeplatte Detail.

WIRE MANAGEMENT



Magnetic vertical cable management and vertical cable management.
Sube-cables imantado y electrificación vertical.
Magnetische Kabelführung und Vertikale Kabelführung.

ACCESSORIES



CPU support.
Soporte CPU.
CPU Halterung.

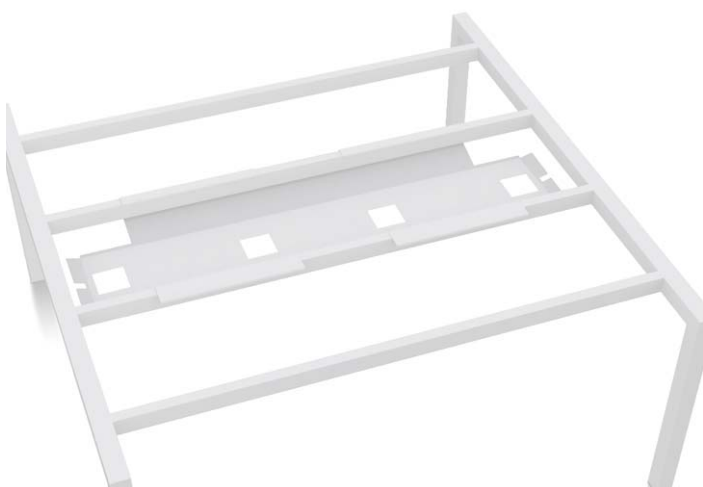

Double or single cable tray.
Canal electrificación doble y simple.
Kabelkanal einfach oder doppelt.



Technical rail and perforated modesty panel.
Porta accesorios y faldón chapa perforada.
Hängeschielen und Sichtschutz perforiert.

MEETING





Sliding cover, open and closed, with cable management tray.
Detalle de tapa deslizante abierta y cerrada con bandeja de electrificación.
Einzelheit geöffnete und geschlossene verschiebbare Abdeckung mit Kabelkanal.





MEETING

•

Meeting areas are a common feature of office spaces. The requirements of each particular office may vary greatly. There are larger offices with a small meeting table arranged alongside a work desk, open-plan areas with meeting tables for small groups of people bordering group work areas, special conference rooms for larger groups, etc.

Tec offers a wide range of solutions, ranging from individual tables in different formats to tables that can be arranged together, ideal when it comes to meeting different staff requirements.

••

Es un uso habitual dedicar espacios destinados a reunión. Las necesidades en la oficina pueden ser de lo más heterogéneas. Podemos encontrar despachos en los que por su amplitud pueden convivir la mesa de trabajo con una pequeña mesa de reuniones, áreas abiertas anexas a zonas de trabajo colectivo con mesas de reunión para un pequeño grupo de personas, salas específicas destinadas a reuniones de grandes grupos, etc.

Tec cuenta con una amplia gama de soluciones que varía entre mesas individuales de varios formatos y mesas componibles, ideales cuando las necesidades de personal son importantes.

••

In den meisten Fällen sind Räumlichkeiten für Besprechungen erforderlich. Die Bedürfnisse im Büro können äußerst unterschiedlich sein. Es gibt Büros, die auf Grund ihrer Größe die Einrichtung mit einem Arbeitstisch und einem kleinen Besprechungstisch zulassen, an kollektive Arbeitsbereiche angeschlossene offene Räumlichkeiten mit Besprechungstischen für kleine Gruppen, spezifische Räume für Besprechungen in großen Gruppen usw.

Tec bietet eine breite Palette an Lösungsmöglichkeiten von Einzel-Arbeitsplätzen in verschiedenen Größen bis hin zu modularen Tischen, die ideal sind, wenn ein hoher Personalbedarf besteht.

SPECIAL SOLUTIONS

This variant has the highest cable management capacity. The table assimilates all the technical and equipment installation cabling requirements and maintains its aesthetic tidiness.

It is available in two different options: flush cable management and superior cable management. The flush cable management version has two aluminium extrusion pieces where the different screens and accessories are fitted, doubling the optimisation possibilities and maximising workspace usage.

When the superior cable management is used, access to the cables in the cable management is gained through two folding covers that convert this solution into the highest capacity for cabling the workstation.

La variante con más capacidad de electrificación. La mesa llega a asimilar toda la instalación técnica y de equipos manteniendo su limpieza estética.

Esta disponible en dos opciones diferentes: canal enrasado y canal sobre - elevado.

La versión canal enrasado dispone de dos perfiles de aluminio donde se colocan los distintos paneles y accesorios, duplicando, si cabe, las posibilidades de optimización y aprovechamiento de espacios de trabajo.

Cuando el canal es sobre-elevado, el acceso del cableado al canal de electrificación es mediante dos tapas abatibles que convierten a este puesto en la solución más potente de electrificación.

Die Variante mit mehr Kapazität für Elektrizitätsanschluss. Der Tisch kann die gesamte technische Installation und die Geräte unterbringen und dabei seine ästhetische Reinheit bewahren.

Wir können zwischen zwei Möglichkeiten wählen: ein eingearbeiteter (versenkter) Kanal oder ein aufgebrachter (überstehender) Kanal. Die Version mit dem eingearbeiteten Kanal verfügt über zwei Aluminiumprofile, auf denen verschiedene Paneele und Zubehör befestigt werden können. Auf diese Weise verdoppeln sich die Möglichkeiten einer optimalen Raumnutzung im Arbeitsbereich.

Wenn der Kanal aufgebracht ist, erfolgt der Zugriff für die Verkabelung zum Elektroanschluss über zwei klappbare Abdeckungen, die den Arbeitsplatz mit einer stärkeren Lösung für den Elektroanschluss ausstatten.









SPECIAL SOLUTIONS

•

This is a fusion with the Nexus panel.

In this case the table is supported by one of the ends of the panel, which also doubles as a separation element without diminishing its functional characteristics: cabling capacity, shelf support, technical panel, various finishes, etc.

••

Se trata de la fusión con el biombo Nexus.

En este caso la mesa apoya uno de sus extremos en el biombo, que además de soporte ejerce como elemento separador, sin perder las prestaciones que ya lo caracterizan: capacidad para electrificación, soporte para estantes, panel técnico, varios acabados, etc.

••

Es handelt sich um eine Fusion mit der Trennwand Nexus.

In diesem Fall stützt sich eines seiner Enden auf die Trennwand, welche nicht nur als Stütze, sondern auch trennendes Element funktioniert. Dabei verliert es keineswegs die Eigenschaften, die es charakterisieren: die Möglichkeit für eine Elektrifizierung, Halterung für Regale, technisches Panel, verschiedene Ausführungen, etc.



FINISHES

ACABADOS · AUSFÜHRUNGEN

POLYESTER PLAIN EPOXY & LACQUERED
 PINTURA EPOXY POLIESTER & LACADOS
 EPOXY-POLYESTER-FARBE & LACKIERUNGEN

METALLIE EPOXY
 PINTURA METALIZADA
 METALLLACKIERUNG

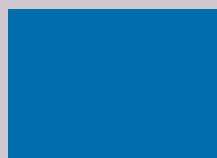

AK Electric blue
Azul electrico



HD Mustard yellow
Amarillo mostaza

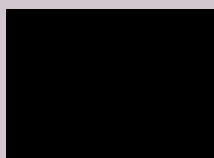

NE Black
Negro

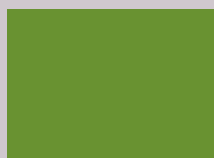

VV Spring green
Verde primavera



CV Bright red
Rojo vivo



GP Platinum grey
Gris platino

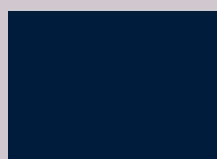

AJ Navy blue
Azul marino



BG Chocolate
Chocolate

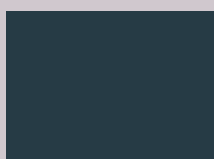

GF Deep grey
Gris profundo

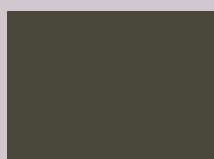

GV Greenish grey
Gris verdoso



CG Burgundy
Granate



GG Graphite grey
Gris grafito



AG Storm blue
Azul roto

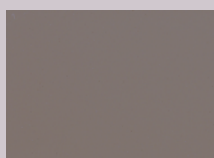

BT Mocha brown
Tostado



GA Anthracite grey
Gris antracita



VT Laurel green
Verde laurel



RO Red
Rojo



AF Ice blue
Azul gélido



BE Smoke
Humo

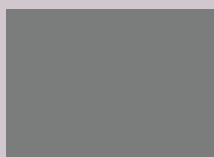

GE Mouse grey
Gris ratón



VG Khaki green
Verde caqui



CD Orange
Naranja



AE Grey blue
Azul grisáceo



BD Stone
Piedra

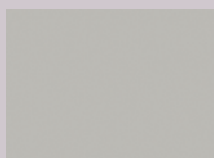

GC Light grey
Gris claro



VP Pistachio green
Verde pistacho



CC Vanilla
Vainilla

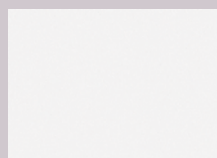

BA White
Blanco

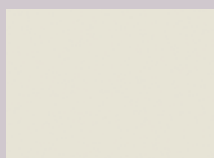

BC Cream white
Blanco crema

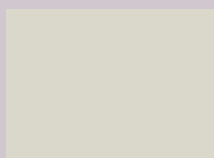

GD Off white
Blanco sucio

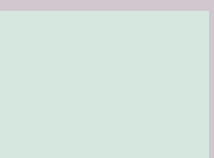

VA Sea blue
Aquamarina



CB Faded white
Blanco roto

The finishes whose code is shown in red have an increase over the rate of 3%.

Los acabados cuyo código está representado en rojo tienen un incremento respecto a la tarifa del 3%.
 Die in rot vermerkten Ausführungen bedeuten einen Aufpreis von 3% auf den Listenpreis.

WOOD

MADERA
ECHTHOLZ



RB White oak
Roble blanco



MB White s.g.
Mallada blanca

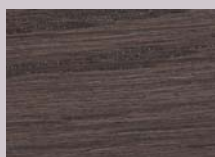

RG Grey oak
Roble gris

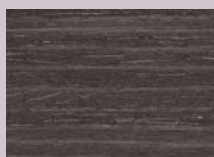

MG Grey s.g.
Mallada gris

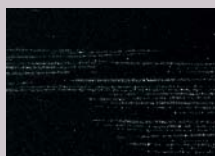

RS Black oak
Roble negro



MS Black s.g.
Mallada negra



RC Cream oak
Roble crema



MC Cream s.g.
Mallada crema

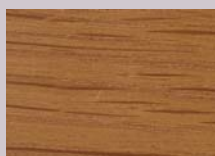

RD Honey oak
Roble miel



MD Honey s.g.
Mallada miel



RP Brown oak
Roble marrón

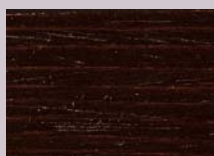

MP Brown s.g.
Mallada marrón

HPL (Table top)

HPL (Encimera mesa)
HPL (Oberfläche tisch)

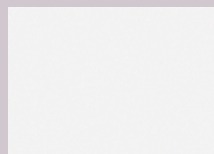

BA White
Blanco



AU Birch
Abedul

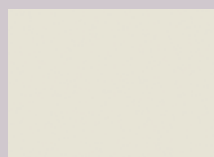

BC Cream white
Blanco crema



RM Oak
Roble

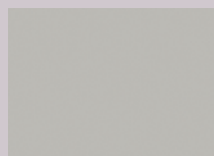

GC Light grey
Gris claro



AA Acacia
Acacia

FINISHES

ACABADOS · AUSFÜHRUNGEN

LAMINATE (Table top)

LAMINADO (Encimera mesa)

LAMINAT (Oberfläche tisch)

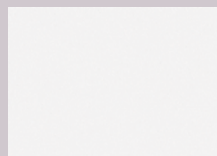

BA White
Blanco



AU Birch
Abedul

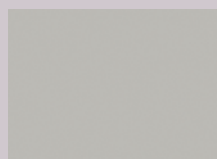

GC Light grey
Gris claro

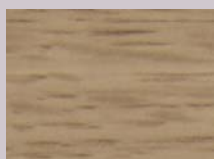

RM Oak
Roble

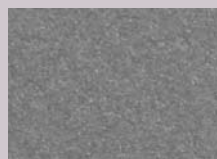

GP Platinum grey
Gris platino

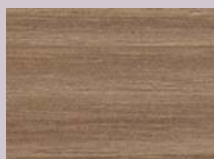

AA Acacia
Acacia

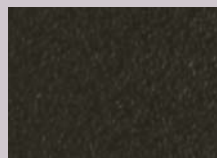

GU Ugu
Ugu

LAMINATE (Screen and modesty panel)

LAMINADO (Panel y faldón)

LAMINAT (Paneel und Sichtschutz)

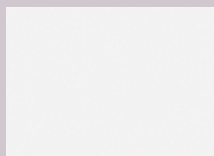

BA White
Blanco



AU Birch
Abedul

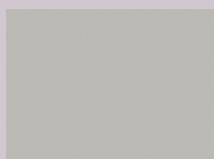

GC Light grey
Gris claro

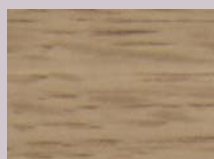

RM Oak
Roble



GP Platinum grey
Gris platino

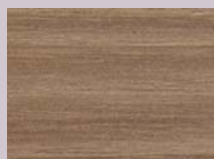

AA Acacia
Acacia

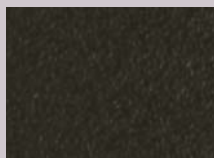

GU Ugu
Ugu

FABRICS

TAPIZADOS · BEZUGSTOFF

FABRIC 13 (Screen)
COLECCIÓN 13 (Panel)
KOLLEKTION 13 (Panneel)

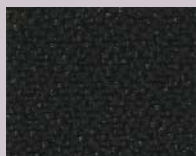

1320



1360



1311



1357



1310



1382



1341



1340



1331

FABRIC 31 (Screen)
COLECCIÓN 31 (Panel)
KOLLEKTION 31 (Panneel)

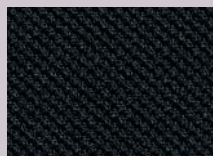

3120



3161

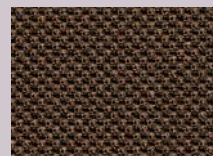

3190

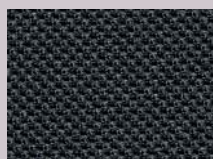

3111

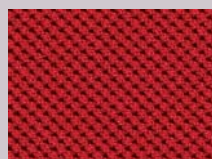

3160



3181



3110



3157



3180

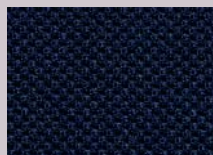

3142

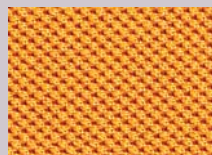

3156



3141

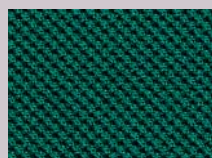

3131



3140



3130

TEC

Rectangular desk.

Mesa rectangular.
Rechteckiger-Tisch.

F	100	A	80	100	120	140	160	180	200
F	90	A	80	100	120	140	160	180	200
F	80	A	80	100	120	140	160	180	200
F	70	A	80	100	120	140	160	180	200
F	60	A	80	100	120	140	160	180	200

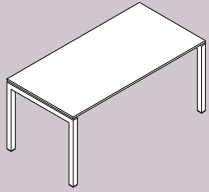

Return for freestanding desk.

Ala para mesa independiente.
Flügel für freistehenden Tisch.

F	60	A	80	100	120
---	----	---	----	-----	-----

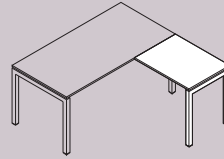

Rectangular desk (side desk, middle desk, end desk).

Mesa rectangular (mesa inicial, intermedia y final).
Rechteckiger-Tisch (Anfangsposition, Zwischenposition, Endposition).

F	80	A	80	100	120	140	160	180	200
F	70	A	80	100	120	140	160	180	200
F	60	A	80	100	120	140	160	180	200

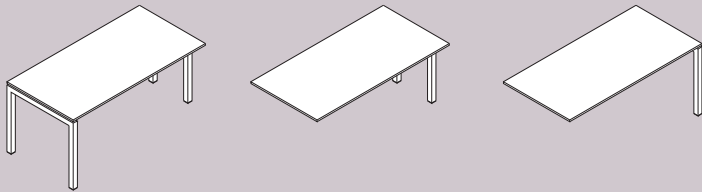

Facing desks (side desk, middle desk, end desk).

Mesas enfrentadas (mesa inicial, intermedia y final).
Doppeltisch (Anfangsposition, Zwischenposition, Endposition).

F	100	FT	200	A	80	100	120	140	160	180	200
F	90	FT	180	A	80	100	120	140	160	180	200
F	80	FT	160	A	80	100	120	140	160	180	200
F	70	FT	140	A	80	100	120	140	160	180	200
F	60	FT	120	A	80	100	120	140	160	180	200

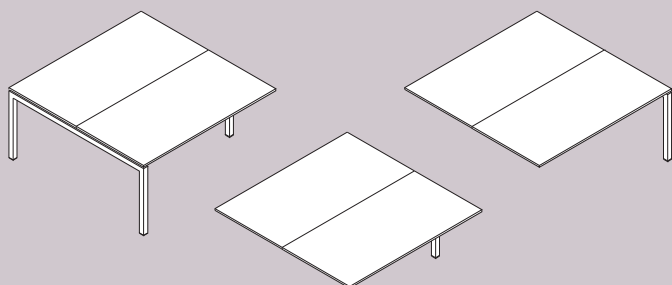

Extension table for facing desks.

Mesa cabecera para mesas enfrentadas.
Kopftisch für Doppeltisch.

F	80	FT	160
F	90	FT	180

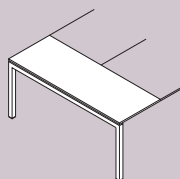

Facing desks prepared for panel and Tec 2 profile.

Mesas enfrentadas preparadas para panel y perfil Tec 2.
Doppeltisch mit Paneel oder Profil Tec2.

F 100	FT 203	A 80	100	120	140	160	180	200
F 90	FT 183	A 80	100	120	140	160	180	200
F 80	FT 163	A 80	100	120	140	160	180	200
F 70	FT 143	A 80	100	120	140	160	180	200
F 60	FT 123	A 80	100	120	140	160	180	200

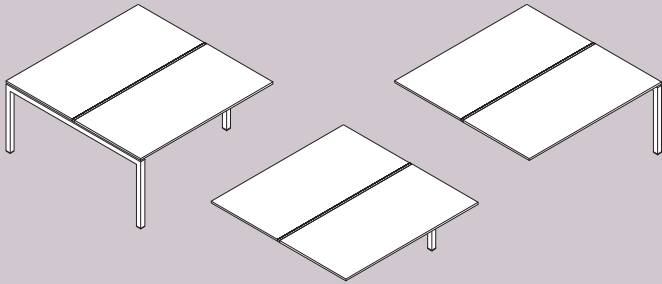

Frontal panel individual desk.

Panel frontal para mesa individual.
Frontales paneel für einzelarbeitsplatz.

H 26,5	HT 100	F 80	100	120	140	160	180	200
H 46,5	HT 120	F 80	100	120	140	160	180	200

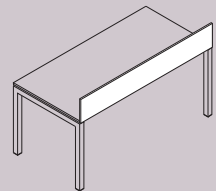

Final lateral panel individual desk.

Panel lateral para mesa individual.
Seitliches paneel für einzeltisch aussenposition.

H 26,5	HT 100	F 60	70	80	90	100
H 46,5	HT 120	F 60	70	80	90	100

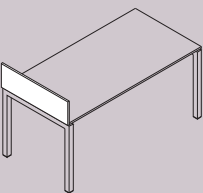

Extension table for facing desks or Tec 2 profile.

Mesa cabecera para mesas enfrentadas con panel o perfil Tec 2.
Kopftisch für Doppeltisch mit paneel oder profil Tec 2.

F 80	FT 163
F 90	FT 183

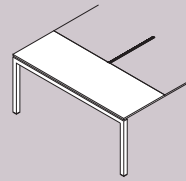

Frontal panel to facing desk.

Panel frontal para mesas enfrentadas.
Frontales paneel für doppeltisch.

H 26,5	HT 100	F 80	100	120	140	160	180	200
H 46,5	HT 120	F 80	100	120	140	160	180	200

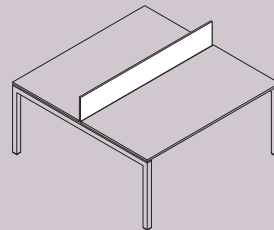

Middle lateral panel individual desk.

Panel lateral intermedio para mesas individuales.
Seitliches paneel für einzeltisch zwischenposition.

H 26,5	HT 100	F 60	70	80	90	100
H 46,5	HT 120	F 60	70	80	90	100

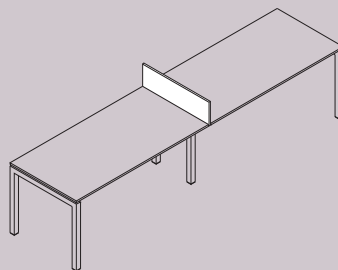

TEC

Final lateral panel facing desks without frontal panel.

Panel lateral extremo para mesas enfrentadas sin panel.

Seitliches paneel aussenposition für doppeltisch ohne frontales paneel.

H 26,5 HT 100 F 120 140 160 180 200

H 46,5 HT 120 F 120 140 160 180 200

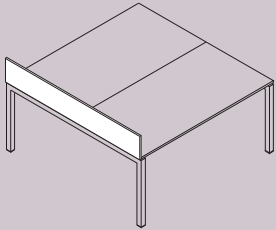

Middle lateral panel facing desks without frontal panel.

Panel lateral intermedio para mesas enfrentadas sin panel.

Seitliches paneel zwischenposition für doppeltisch ohne frontales paneel.

H 26,5 HT 100 F 120 140 160 180 200

H 46,5 HT 120 F 120 140 160 180 200

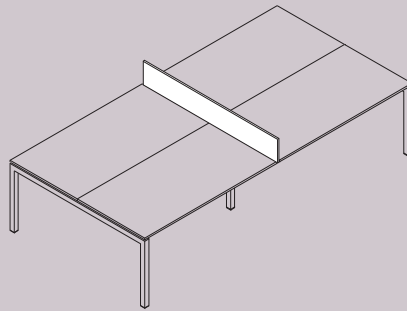

Final lateral panel facing desks with frontal panel.

Panel lateral extremo para mesas enfrentadas con panel.

Seitliches paneel aussenposition für doppeltisch mit frontales paneel.

H 26,5 HT 100 F 123 143 163 183 203

H 46,5 HT 120 F 123 143 163 183 203

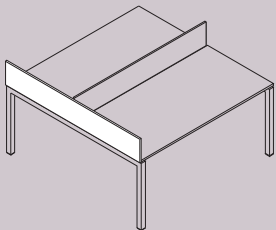

Middle lateral panel facing desks with frontal panel.

Panel lateral intermedio para mesas enfrentadas con panel.

Seitliches paneel zwischenposition für doppeltisch mit frontales paneel.

H 26,5 HT 100 F 123 143 163 183 203

H 46,5 HT 120 F 123 143 163 183 203

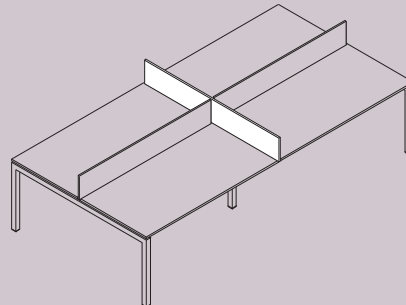

MEETING • REUNIONES • BESPRECHUNGSTISCH

Square meeting table.

Mesa de reuniones cuadrada.
Konferenz Tisch quadratisch.

F 100 A 100
F 140 A 140

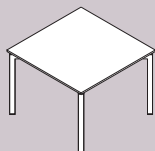

Rectangular meeting table.

Mesa de reuniones rectangular.
Konferenz Tisch rechteckig.

F 120 A 180 240

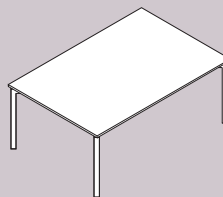

Round meeting table.

Mesa reuniones redonda.
Besprechungstisch rund.

F 100 A 100
F 120 A 120



Modular meeting table (side desk - end desk).

Mesa reuniones componible (mesa inicial - mesa final).
Besprechungstisch (Anfangsposition - Endposition).

F 120 A 80 120 180 240
F 160 A 80 120 180 240

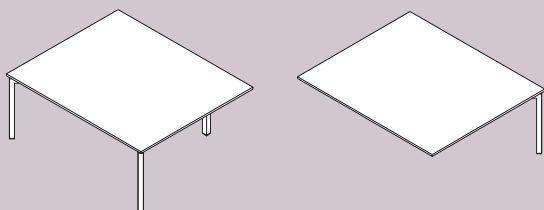

Modular meeting table (middle desk).

Mesa reuniones componible (mesa intermedia).
Besprechungstisch (Zwischenposition).

F 120 A 120 180 240
F 160 A 120 180 240

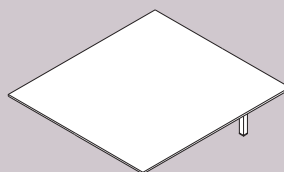

TEC

WIRING EXIT • SALIDA DE CABLES • KABELAUSLASS

Aluminium flip up cover.

Tapa abatible aluminio frontal.
Frontale Klappe Aluminium.

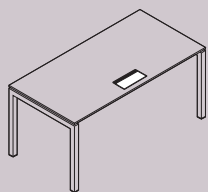

Frontal sliding cover.

Tapa deslizante frontal.
Frontale Schiebeabdeckung.

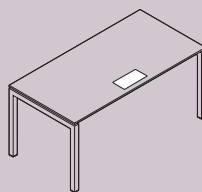

Frontal laminated flip up cover.

Tapa abatible frontal laminado.
Frontale Klappe.

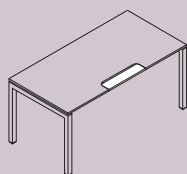

Side flip up cover with tray.

Tapa abatible lateral con bandeja.
Seitliche Klappe mit Träger.

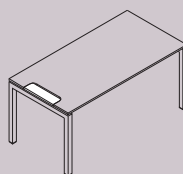

Vertical cable management.

Electrificación vertical.
Vertikale Kabelführung.

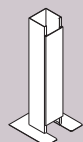

Wiring exit.

Pasacables.
Kabelabführung.

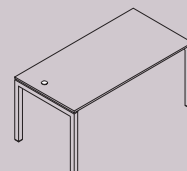

The product and its range can be changed. Check price list to see current conditions.

El producto y su gama pueden sufrir modificaciones. Consultar tarifa para ver condiciones vigentes.

Das Produkt und seine Reichweite verändert werden kann. Siehe Preisliste an die aktuellen Bedingungen zu sehen.

WIRE MANAGEMENT • ELECTRIFICACIÓN • KABELKANAL

Double sided cable tray.

Canal de electrificación doble.
Kabelführung doppelt.

A 80 100 120 140 160 180 200

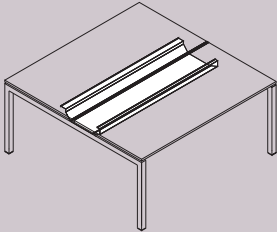

ACCESSORIES • COMPLEMENTOS • ZUBEHÖR

Modesty panel (plain or perforated sheet).

Faldón (plano o perforado).
Sichtschutz (Durchgehend oder Perforiert).

H 30 A 80 100 120 140 160 180 200

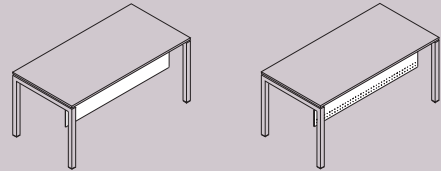

Single sided cable tray.

Canal de electrificación simple.
Kabelführung einfach.

A 80 100 120 140 160 180 200

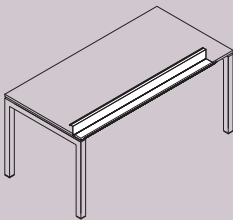

Technical rail for upholstered panel.

Porta accesorios panel tapizado.
Hängeschienen für gepolstertes paneel.

A 80 100 120 140 160 180 200

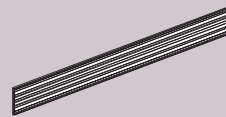

Magnetic electrification.

Sube-cables imantado.
Magnetische Kabelführung.

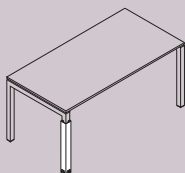

CPU support.

Soporte CPU.
CPU Halterung.

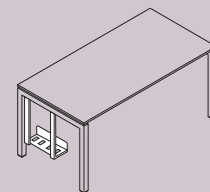

Movinord

Office Concept

Λεωφ. Κηφισίας 256, Χαλάνδρι Τ.Κ. 152 31
ΤΗΛ. +30 210 6141550, 210 2532233, FAX: +30 210 2532235

Λαέρτου 22, Πυλαία, Θεσσαλονίκη, Capital Trade Center, κτίριο C
ΤΗΛ./Fax. +30 2310 472584, ΚΙΝ. +30 6947004736

info@movinord.com.gr
www.movinord.com.gr